



City of West Allis

Meeting Agenda

Common Council

Mayor Dan Devine, Chair

Alderson Thomas G. Lajsic, Council President

Aldersons: Suzzette Grisham, Kevin Haass, Danna Kuehn, Thomas G. Lajsic, Rosalie L. Reinke, Daniel J. Roadt, Tracy Stefanski, Vincent Vitale, and Martin J. Weigel

Tuesday, November 15, 2022

7:00 PM

City Hall, Common Council Chambers
7525 W. Greenfield Avenue

REGULAR MEETING

A. CALL TO ORDER

B. ROLL CALL

C. PLEDGE OF ALLEGIANCE

Led by Ald. Roadt.

D. PUBLIC HEARING

1. [O-2022-0163](#) Ordinance to amend section 19.01, the Official West Allis Zoning Map, for certain properties in alignment with the 2040 Comprehensive Plan.

Sponsors: Safety and Development Committee

E. CITIZEN PARTICIPATION

The Common Council may receive information from members of the public during this 30-minute period. Each speaker must announce to the council his or her name and address, sign in at the podium, and limit comments to one statement of no more than 5 minutes. The council cannot take action on topics raised by speakers and will not discuss topics with speakers.

F. ANNOUNCEMENT OF RECESS MEETINGS OF STANDING COMMITTEES

New and Previous Matters referred to Committees may be considered and acted upon by Committees during the Common Council recess. Unless otherwise announced during the meeting, the standing Committees of the Common Council will meet during recess in the following rooms and in the following order:

Art Gallery - Administration & Finance and Safety & Development

Room 128 - License & Health, Public Works & Advisory

The general public may contact the Committee Chair relative to an agenda item of interest that could be discussed or acted on during the recess meetings simultaneously occurring in different conference rooms. Additionally, if a member has interest in multiple agenda items which are scheduled for discussion or action during the recess meetings simultaneously occurring, they should contact the chair of the committee to inform of such interest.

G. MAYOR'S REPORT

This item is a report from the Mayor to the public regarding recent events attended, awards and commendations, and upcoming events. No discussion or action shall take place by members of the Council unless otherwise listed below.

H. ALDERPERSON'S REPORT

This item is a report from individual Alderpersons to the public regarding recent events attended, awards and commendations, and upcoming events. No discussion or action shall take place by members of the Council unless otherwise listed below.

I. APPROVAL OF MINUTES

2. [2022-1079](#) November 1, 2022 Draft Common Council Minutes.

Recommendation: Approve

J. STANDING COMMITTEE REPORTS

None.

K. ITEMS NOT REFERRED TO COMMITTEE (CONSENT AGENDA)

3. [O-2022-0165](#) Ordinance authorizing the use of no-trespass orders at all city parks.

Recommendation: Pass

Sponsors: Alderperson Roadt, Alderperson Weigel and Alderperson Vitale

4. [O-2022-0166](#) Ordinance amending placement rules for facilities located in the right-of-way.

Recommendation: Pass

Sponsors: Alderperson Roadt

5. [R-2022-0643](#) Resolution to approve an increase in the economic development loan assistance to Ope Brewing Company, LLC and West Allis Brewing Property, LLC to assist with increased costs and additional equipment for the establishment of a brewery and entertainment venue at 6749-51 W. National Avenue.

Recommendation: Place on File

Sponsors: Administration and Finance Committee

6. [R-2022-0791](#) Resolution relative to the agreement with the Village of Greendale for Public Health Services for the year 2023.

Recommendation: Adopt

7. [R-2022-0796](#) Resolution to approve bid of Musson Bros., Inc. for sanitary sewer connection liners in various locations in the City of West Allis in the amount of \$299,950.
Recommendation: Adopt
Sponsors: Public Works Committee
8. [R-2022-0797](#) Resolution to approve bid of Visu-Sewer for sanitary and storm sewer lining, spot lining and grouting in various locations in the City of West Allis in the amount of \$240,747.50.
Recommendation: Adopt
Sponsors: Public Works Committee
9. [R-2022-0798](#) Resolution authorizing 10-year contract for Axon Officer Safety Plan.
Recommendation: Adopt
Sponsors: Alderperson Haass
10. [2022-1070](#) Claim by Zacarias Alarcon Diaz regarding vehicle damage at I-94 East and Hawley Road on August 17, 2022.
Recommendation: Refer to City Attorney
11. [2022-1076](#) Claim by Assessment Reduction Services, LLC on behalf of Roman Electric Co., regarding excessive assessment for personal property.
Recommendation: Refer to City Attorney
12. [2022-1078](#) Claim by Elizabeth Ritchey regarding vehicle damage at 1036 S. 88th Street on October 31, 2022.
Recommendation: Refer to City Attorney
13. [2022-1086](#) Claim by Jill & Stacy Lehrer regarding vehicle damage at 832 S. 94th Street on November 5, 2022.
Recommendation: Refer to City Attorney
14. [2022-1072](#) Finance Director/Comptroller submitting report for October 2022 indicating City of West Allis checks issued in the amount of \$4,298,323.16.
Recommendation: Place on File

L. COMMON COUNCIL RECESS

M. NEW AND PREVIOUS MATTERS

ADMINISTRATION & FINANCE COMMITTEE

15. [R-2022-0795](#) Resolution authorizing the Economic Development Fire Fund to fund \$32,000 for Bublr Bikes operation in 2022 and 2023 calendar years.
Recommendation: Adopt

16. [R-2022-0788](#) Resolution approving a rate change in the 2023 sanitary sewer usage charge - City Portion.
Recommendation: Adopt
Sponsors: Alderperson Haass
17. [R-2022-0789](#) Resolution approving an increase in the solid waste fund user charge.
Recommendation: Adopt
Sponsors: Alderperson Haass
18. [2022-1043](#) October 17, 2022 Draft Administration and Finance Minutes.
Recommendation: Approve
19. [2022-1002](#) 2023 City of West Allis Mayor's Recommended Budget.
Recommendation: Approve
20. [O-2022-0147](#) Ordinance appropriating the necessary funds for the operation and administration of the City of West Allis for Calendar Year 2023.
Recommendation: Pass
Sponsors: Alderperson Haass

PUBLIC WORKS COMMITTEE

21. [R-2022-0800](#) Resolution Granting a Privilege to Walter Holtz for property located at 7140-44 W. Greenfield Ave. (Tax Key No. 440-0310-000).
Recommendation: Adopt

SAFETY & DEVELOPMENT COMMITTEE

Public Hearing Item (Safety & Development Committee)

22. [O-2022-0163](#) Ordinance to amend section 19.01, the Official West Allis Zoning Map, for certain properties in alignment with the 2040 Comprehensive Plan.
Sponsors: Safety and Development Committee

LICENSE & HEALTH COMMITTEE

23. [2022-1071](#) New Class D Operator (Bartender) Application for Seth House.
(First appearance)
24. [2022-1082](#) New Class D Operator (Bartender) Application for Corey Curtis.
(First appearance)
25. [2022-1077](#) Summons and Complaint in the matter of complaints against Limanski's Pub, 8900 W. Greenfield Avenue, Agent Kathy Goedde.

26. [2022-1083](#) Summons and Complaint in the matter of complaints against Kane's Bar and Grill, 6922 W. Orchard Street, Agent Edward Jones.

27. [2022-1085](#) October 18, 2022 Draft License and Health Committee Minutes.

Recommendation: Approve

ADVISORY COMMITTEE

None.

N. ADJOURNMENT



All meetings of the Common Council are public meetings. In order for the general public to make comments at the committee meetings, the individual(s) must be scheduled (as an appearance) with the chair of the committee or the appropriate staff contact; otherwise, the meeting of the committee is a working session for the committee itself, and discussion by those in attendance is limited to committee members, the mayor, other alderpersons, staff and others that may be a party to the matter being discussed.

NOTICE OF POSSIBLE QUORUM

It is possible that members of, and possibly a quorum of, members of other governmental bodies of the municipality may be in attendance at the above-stated meeting to gather information. No action will be taken by any governmental body at the above-stated meeting other than the governmental body specifically referred to above in this notice.

NON-DISCRIMINATION STATEMENT

The City of West Allis does not discriminate against individuals on the basis of race, color, religion, age, marital or veterans' status, sex, national origin, disability or any other legally protected status in the admission or access to, or treatment or employment in, its services, programs or activities.

AMERICANS WITH DISABILITIES ACT NOTICE

Upon reasonable notice the City will furnish appropriate auxiliary aids and services when necessary to afford individuals with disabilities an equal opportunity to participate in and to enjoy the benefits of a service, program or activity provided by the City.

LIMITED ENGLISH PROFICIENCY STATEMENT

It is the policy of the City of West Allis to provide language access services to populations of persons with Limited English Proficiency (LEP) who are eligible to be served or likely to be directly affected by our programs. Such services will be focused on providing meaningful access to our programs, services and/or benefits.



CITY OF WEST ALLIS
NOTICE OF PUBLIC HEARING
Tuesday, November 15, 2022
7:00 p.m.

NOTICE IS HEREBY GIVEN that the Common Council of the City of West Allis will conduct a public hearing on Tuesday November 15, 2022, at 7:00 P.M., or soon thereafter in the Common Council Chambers of West Allis City Hall, 7525 W. Greenfield Avenue, West Allis, Wisconsin on the:

Ordinance to amend section 19.01, the Official West Allis Zoning Map, for certain properties in alignment with the 2040 Comprehensive Plan.

Additional project information, comments or questions or concerns can be addressed by emailing planning@westalliswi.gov or calling 414-302-8460.

You may express your opinion in writing to the clerk@westalliswi.gov, prior to the meeting, or in person at the public hearing at the above date, time and location.

Dated at West Allis, Wisconsin, this October 21
City Clerk
PUBLISH: October 28, 2022 and November 4, 2022
O-2022-0163

NONDISCRIMINATION STATEMENT

The City of West Allis does not discriminate against individuals on the basis of race, color, religion, age, marital or veterans' status, sex, national origin, disability or any other legally protected status in the admission or access to, or treatment or employment in, its services, programs or activities.

AMERICANS WITH DISABILITIES ACT NOTICE

Upon reasonable notice, the City will furnish appropriate auxiliary aids and services, when necessary, to afford individuals with disabilities an equal opportunity to participate in and enjoy benefits of a service, program or activity provided by the City.

LIMITED ENGLISH PROFICIENCY STATEMENT

It is the policy of the City of West Allis to provide language access services to populations of persons with Limited English Proficiency (LEP) who are eligible to be served or likely to be directly affected by our programs. Such services will be focused on providing meaningful access to our programs, services and/or benefits

Exhibit A - Other Rezonings

Map ID	Address	Taxkey	Existing Zoning	Proposed Zoning
1	7415 W BENNETT AVE	515-0125-000	C-3, RA-2	P
2	113** W CLEVELAND AVE	520-9993-005	RA-1	P
3	113** W CLEVELAND AVE	484-9992-001	RC	P
4	11300 W CLEVELAND AVE	484-9991-000	RC	P
5	110** W ARTHUR AVE	484-9999-019	I-1	P
6	23** S 110 ST	484-0100-003	RA-3, RB	P
7	109** W ARTHUR AVE	484-0062-004	C-4	P
8	19** S 67 PL	475-9999-002	I-1, RB, RC	I-1
9	67** W NATIONAL AVE	454-0250-000	I-1, C-3, PUD	C-3
10	8333 W NATIONAL AVE	452-9999-008	I-1, C-2, C-3	C-2
11	18** S 108 ST	449-9979-000	RA-3, RB	I-1
12	18** S 100 ST	449-9978-000	I-1, RA-3, RB	I-1
13	19** S 101 ST	480-9971-000	I-1	RC
14	17** S 96 ST	450-9949-000	I-1, RB	RC
15	1** S 108 ST	414-9989-000	I-1, C-3	C-3
16	1** S 108 ST	415-9999-000	C-3, RA-3	C-3
17	19** S 123 ST	447-9997-000	I-1, RB, P	P
18	6** S 100 ST	416-9969-002	C-3, RB	I-1
19	13** S 98 ST	443-0430-038	C-2, RA-3	RA-3
20	18** S 100 ST	449-0031-005	I-1, C-2, RC	RC
21	101** W NATIONAL	485-9996-003	C-3, RA-2, RC	RA-2
22	8** S 98 ST	443-0001-001	I-1, C-3, RA-3	RA-3
23	15** S 98 ST	450-9988-001	I-1, RB	P
24	27** S 99 ST	518-9944-001	C-3, RA-2	RA-2
25	3049 S 99 ST	518-0253-001	C-3, RA-2	RC
26	19** S 123 ST	447-9996-000	I-1, P, C-3	P
27	18** S 100	449-9976-000	I-1, C-3	I-1
28	1650 S 60 ST	455-0003-000	C-2, RB	RB
29	1655 S 59 ST	455-0011-000	C-2, RB	RB
30	1657 S 59 ST	455-0010-000	C-2, RB	RB
31	1654-56 S 59 ST	438-0705-000	C-2, RB	RB
32	1659-61 S 58 ST	438-0699-000	C-2, RB	RB
33	1661-73 S 57 ST - 5710 W MITCHELL ST	438-0672-000	C-2, RB	C-2
34	1204-10-30 S 61 ST	439-0167-000	C-3, RB	RC
35	1021 S 84 ST	442-0379-001	C-2, RA-3	C-2
36	1556-58 S 83 ST	452-0406-001	I-1, RB	RB
37	8413 W MAPLE ST	452-0441-000	I-1, C-2	C-2
38	1811 S 84 ST	452-0442-001	I-1, C-2	C-2
39	1718-20 S 60 ST	454-0032-001	C-2, RB	RB
40	2373 S 92 ST	486-0017-001	RA-3, RC	RA-3
41	5831 W FILLMORE DR	491-0233-000	RA-3, RB	RA-3
42	3023-25-27-29-31-33 S 91 ST	517-0439-000	RB, RC	RB
43	1933-35 S 60 ST	475-0034-006	I-1, C-2	C-2
44	20** S 67 PL	475-0041-000	I-1, RB	RC
45	1650 S 108 ST	449-9981-009	I-1, C-3	C-3
46	1828 S 76 ST	453-0418-001	C-2, RB	C-2

Rivers

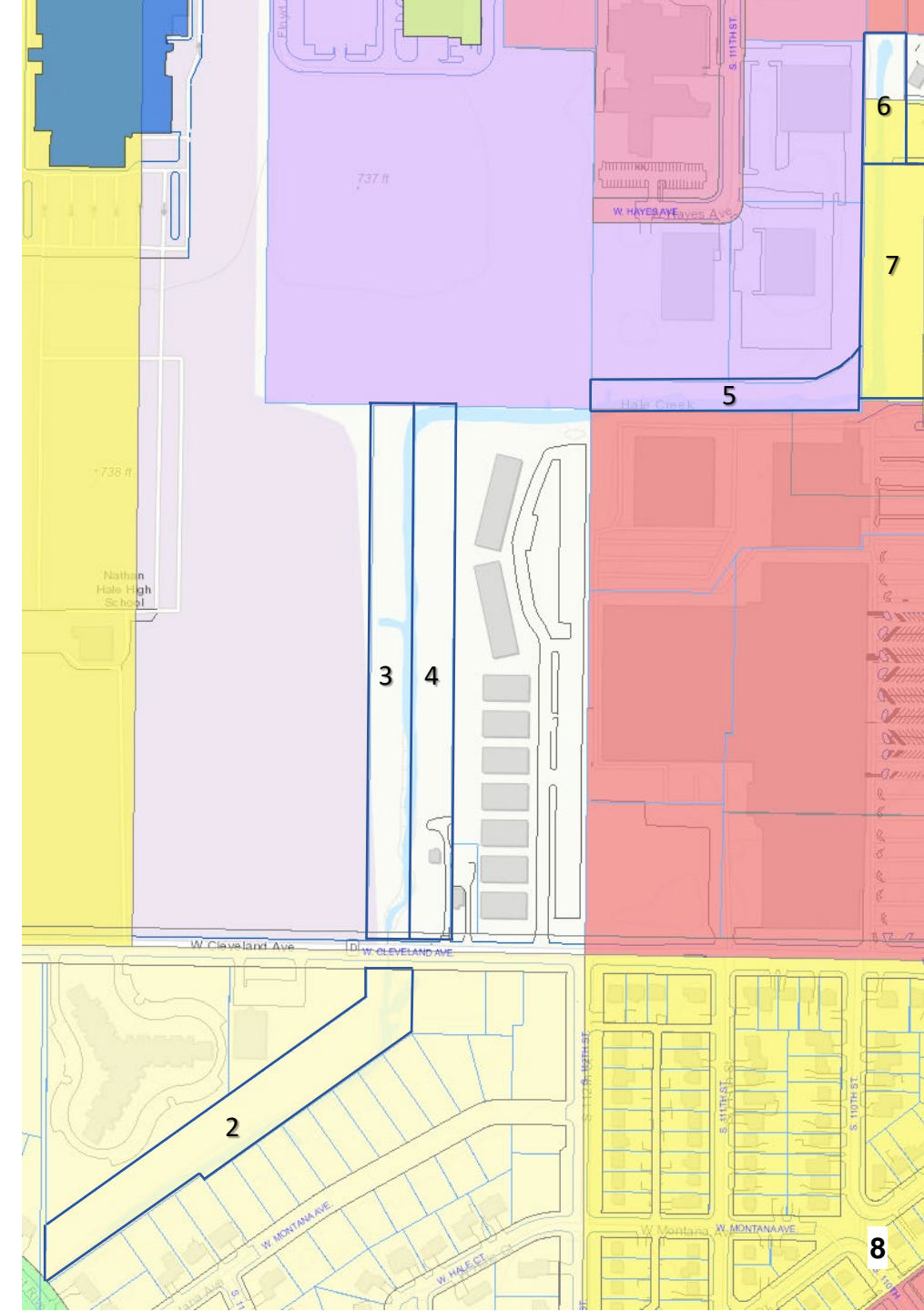
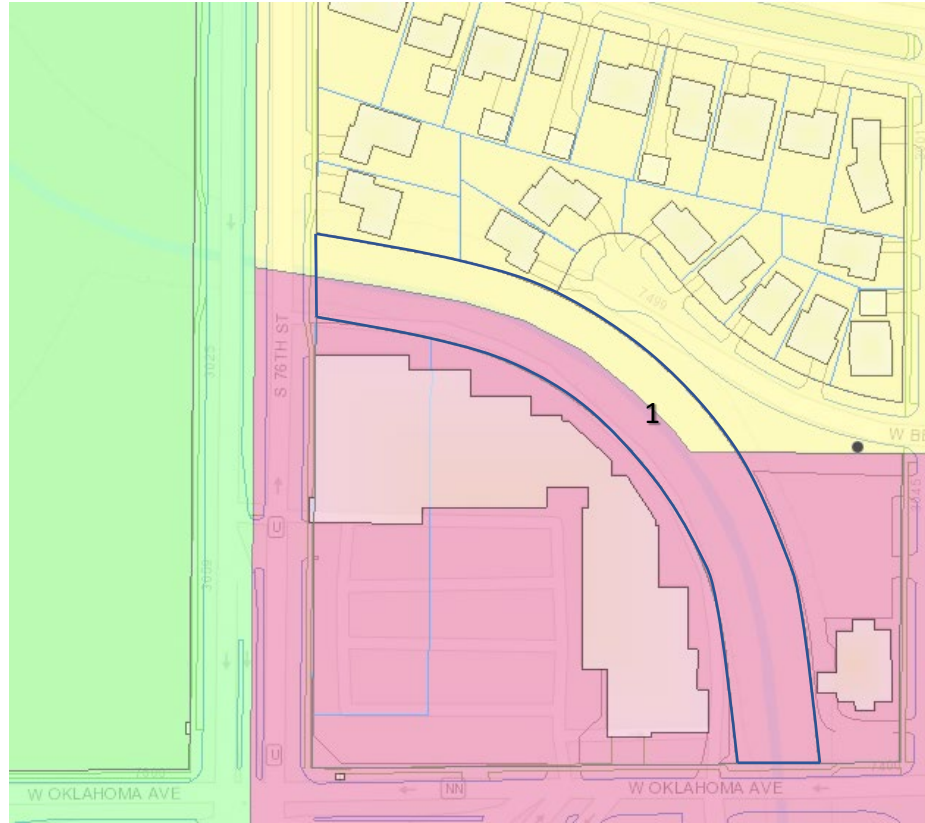

Transportation Corridors

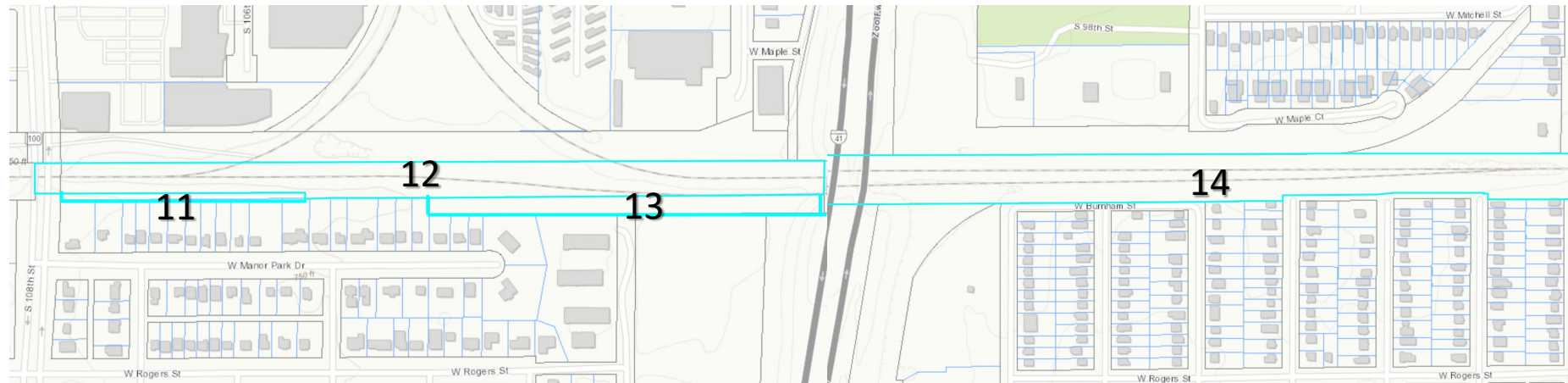
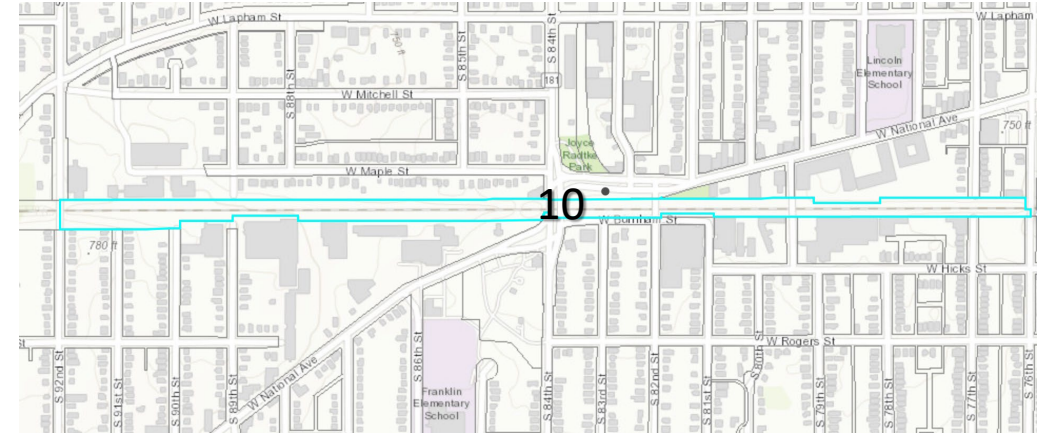
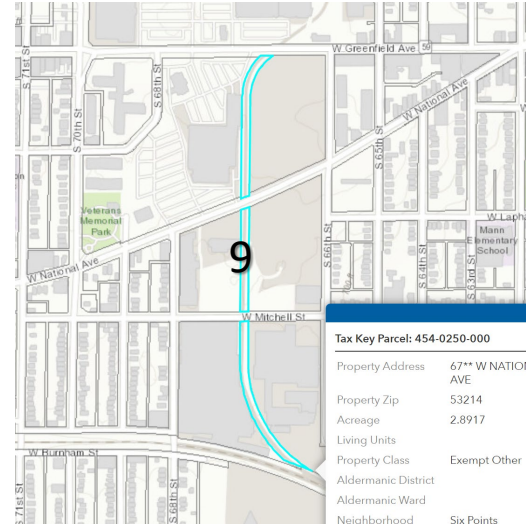
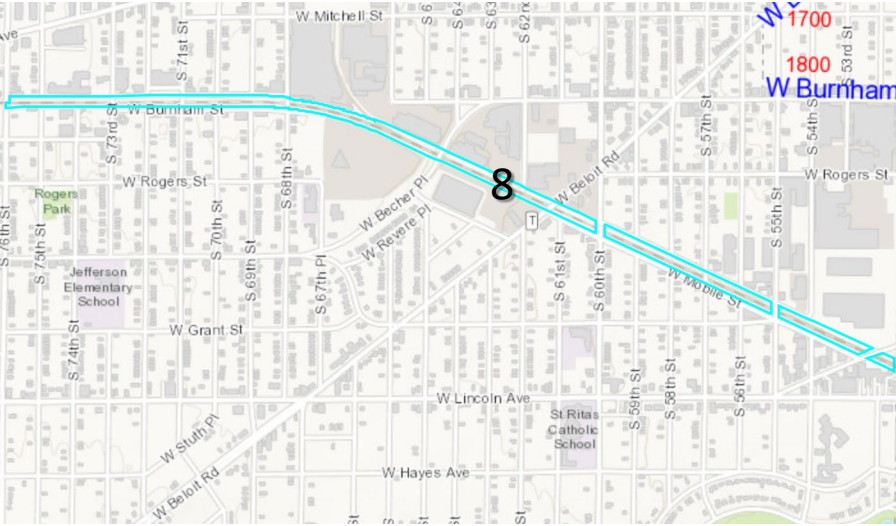

Transportation Corridors

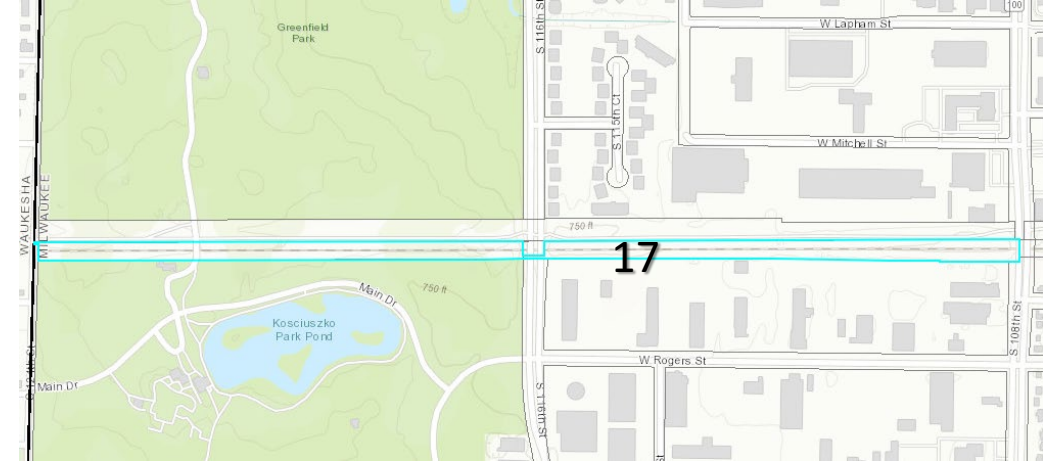
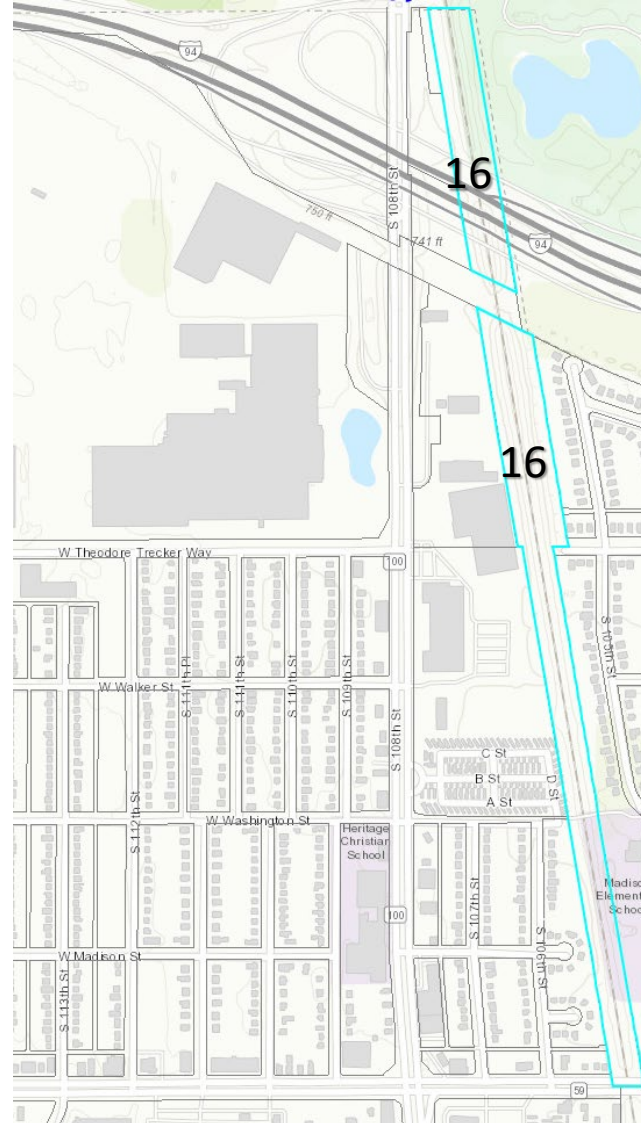
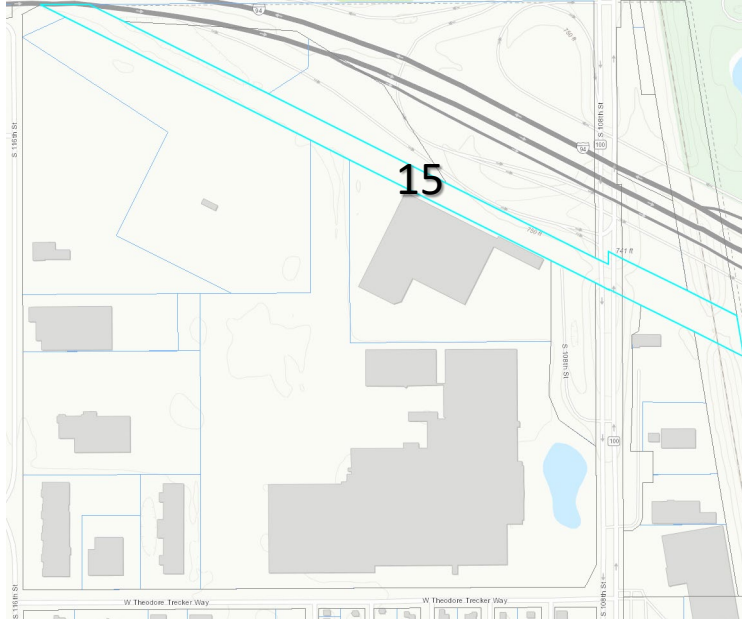

Transportation Corridors

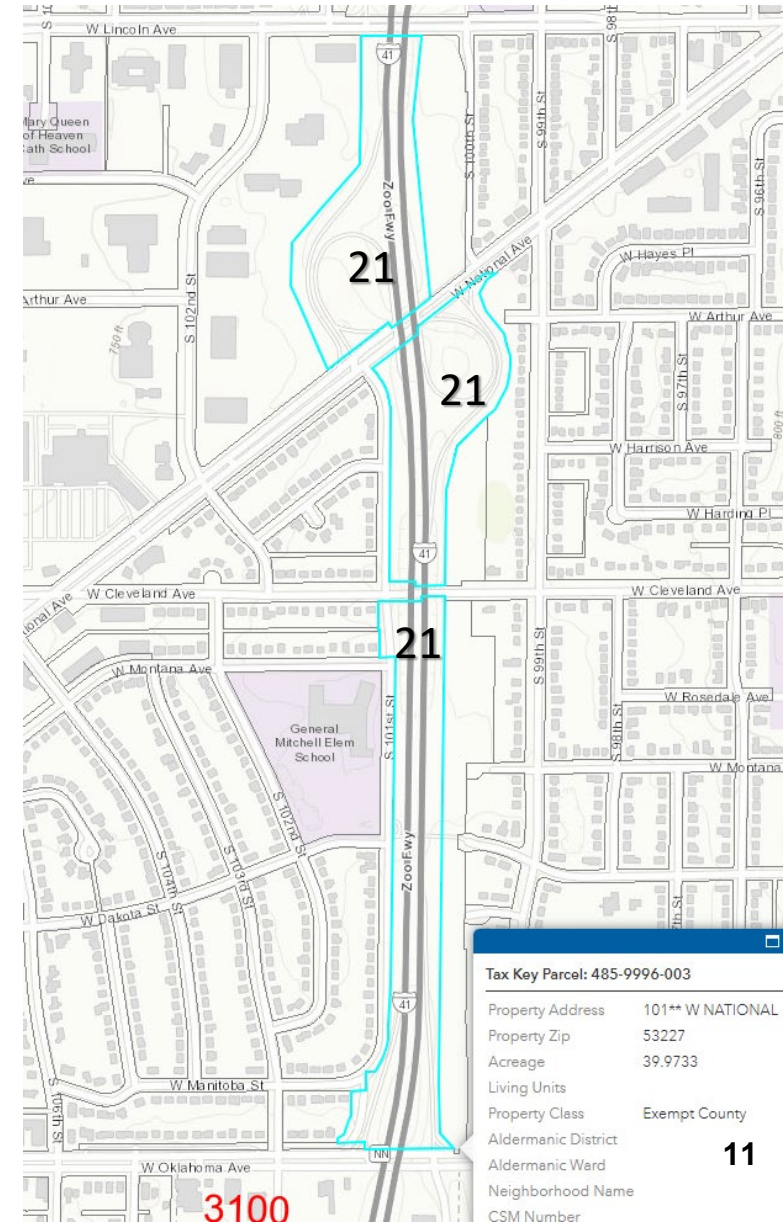
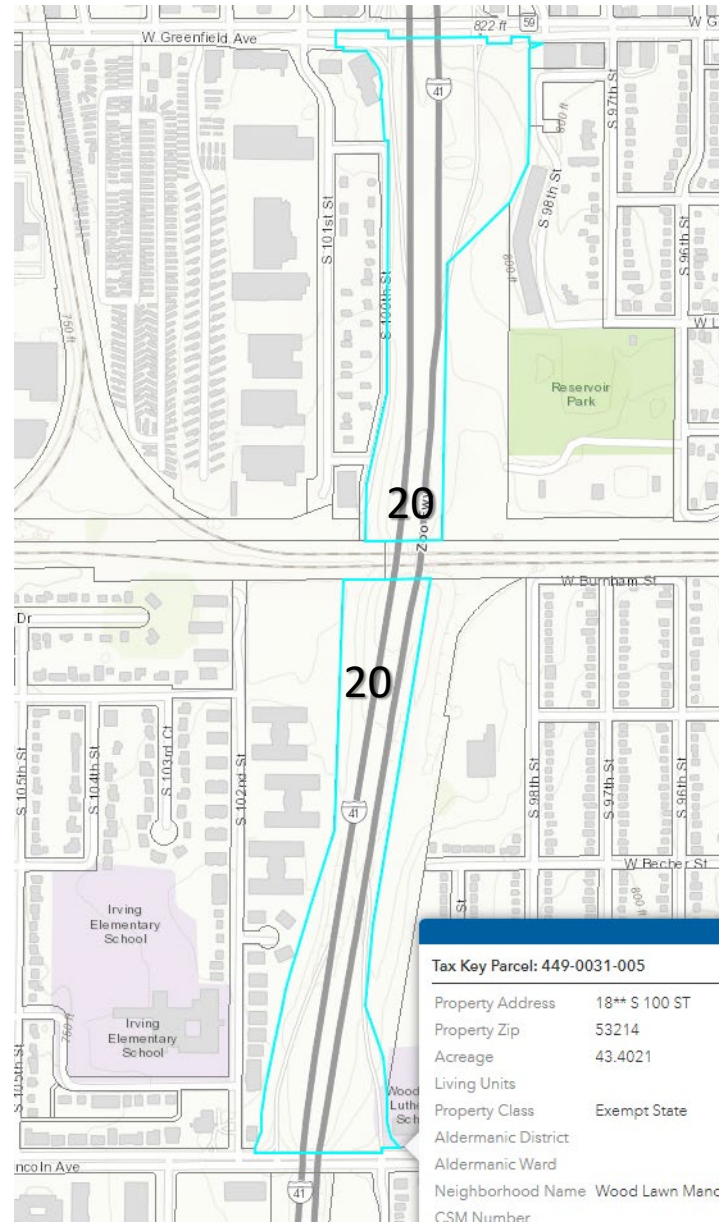
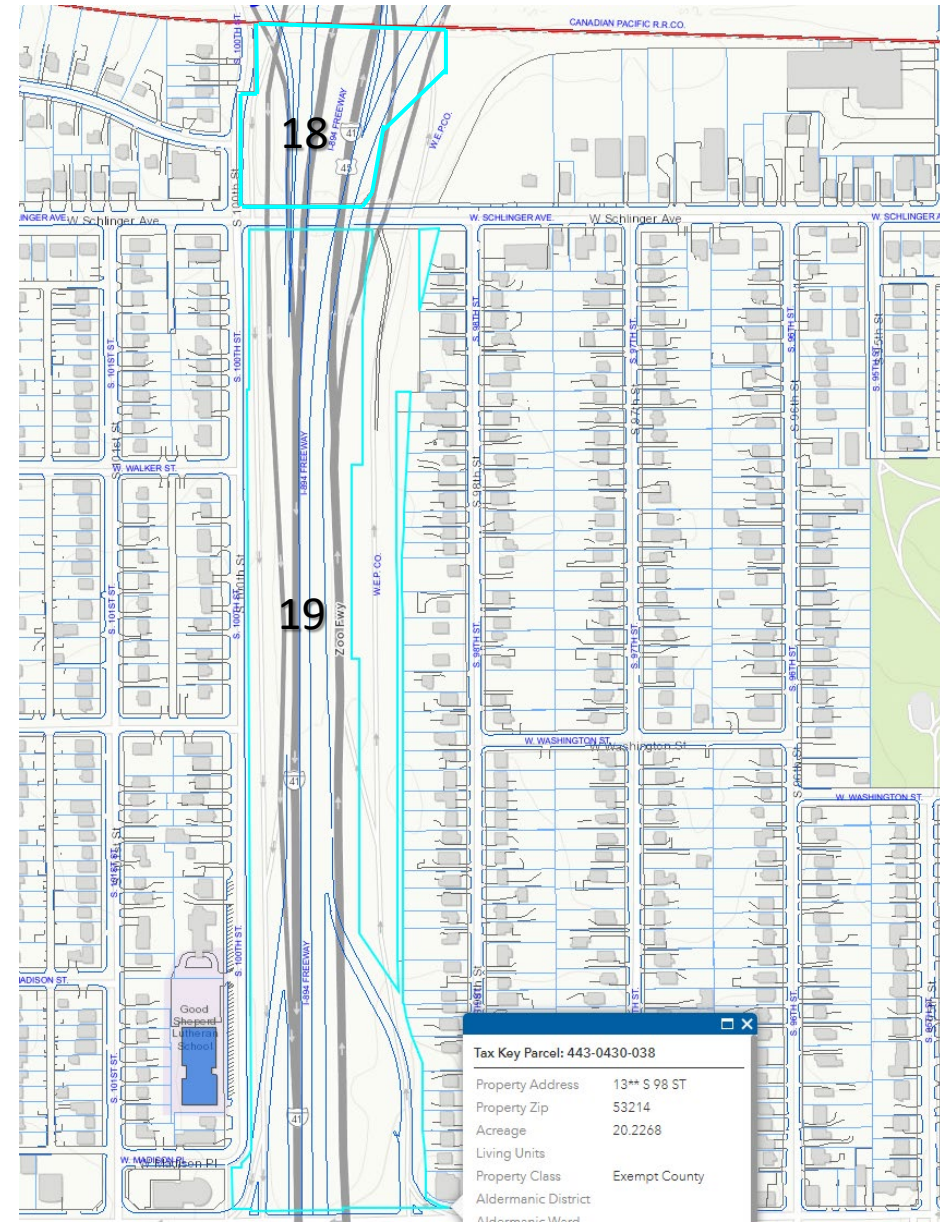

Utility Corridors

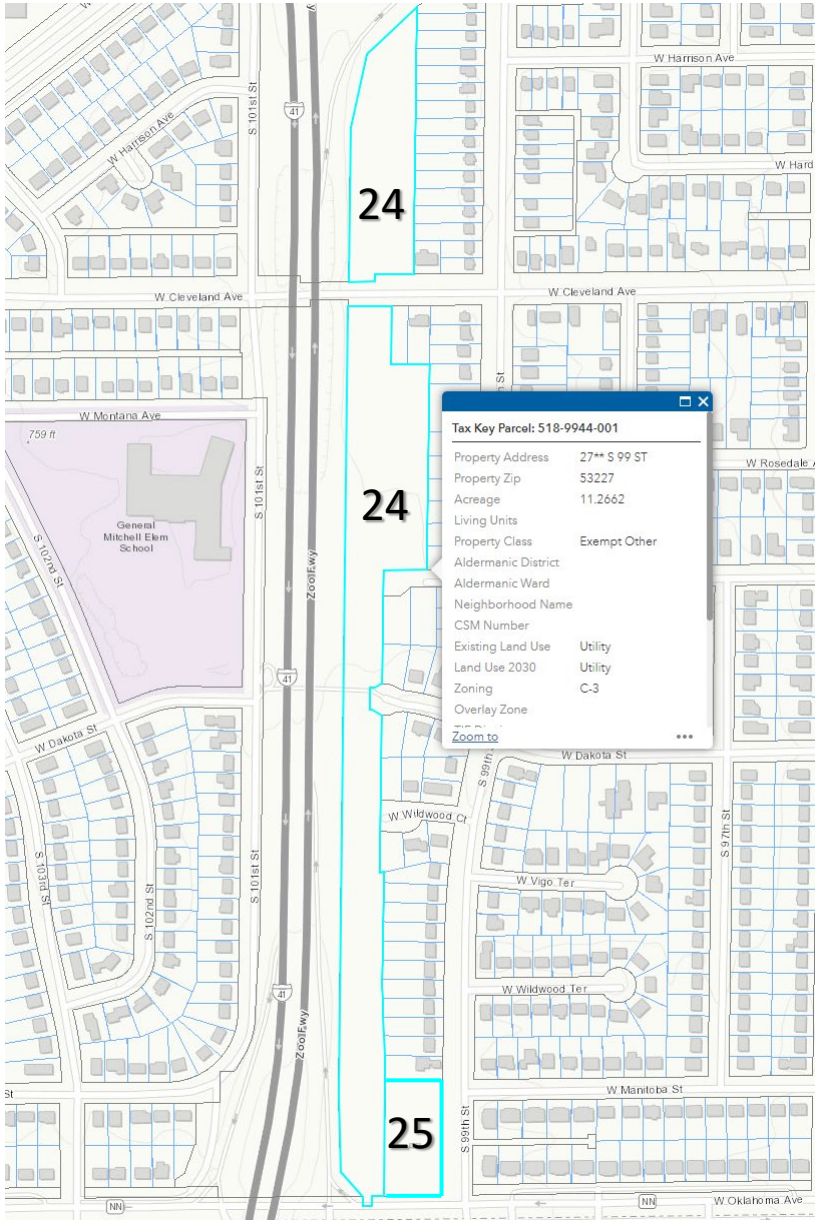
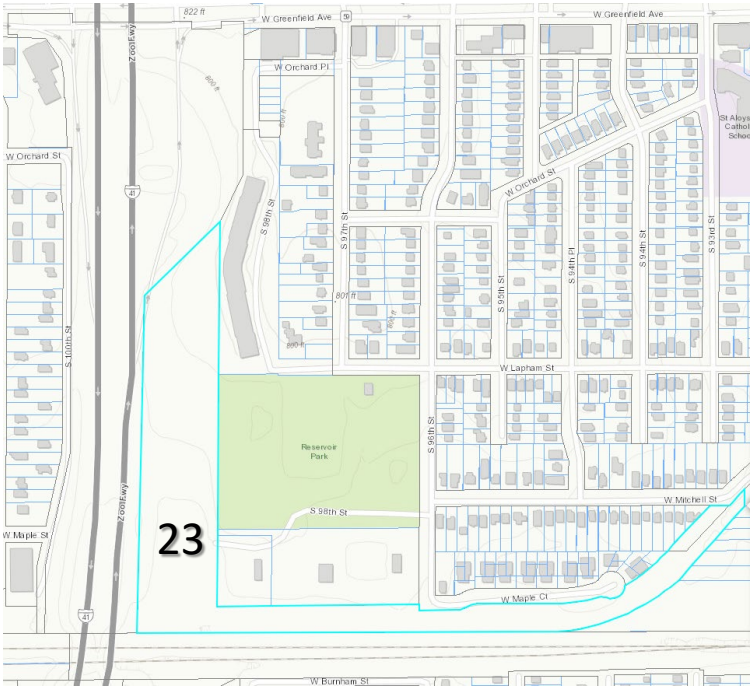
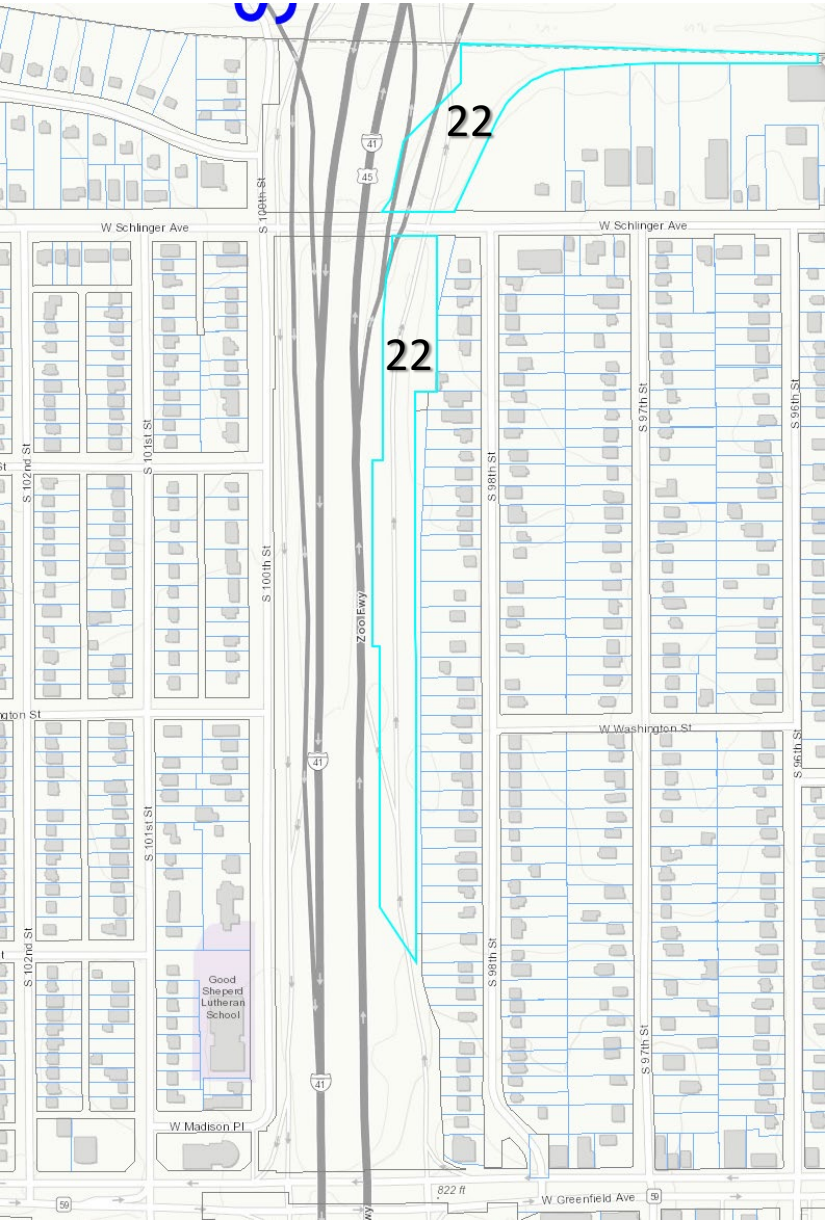

Utility Corridors

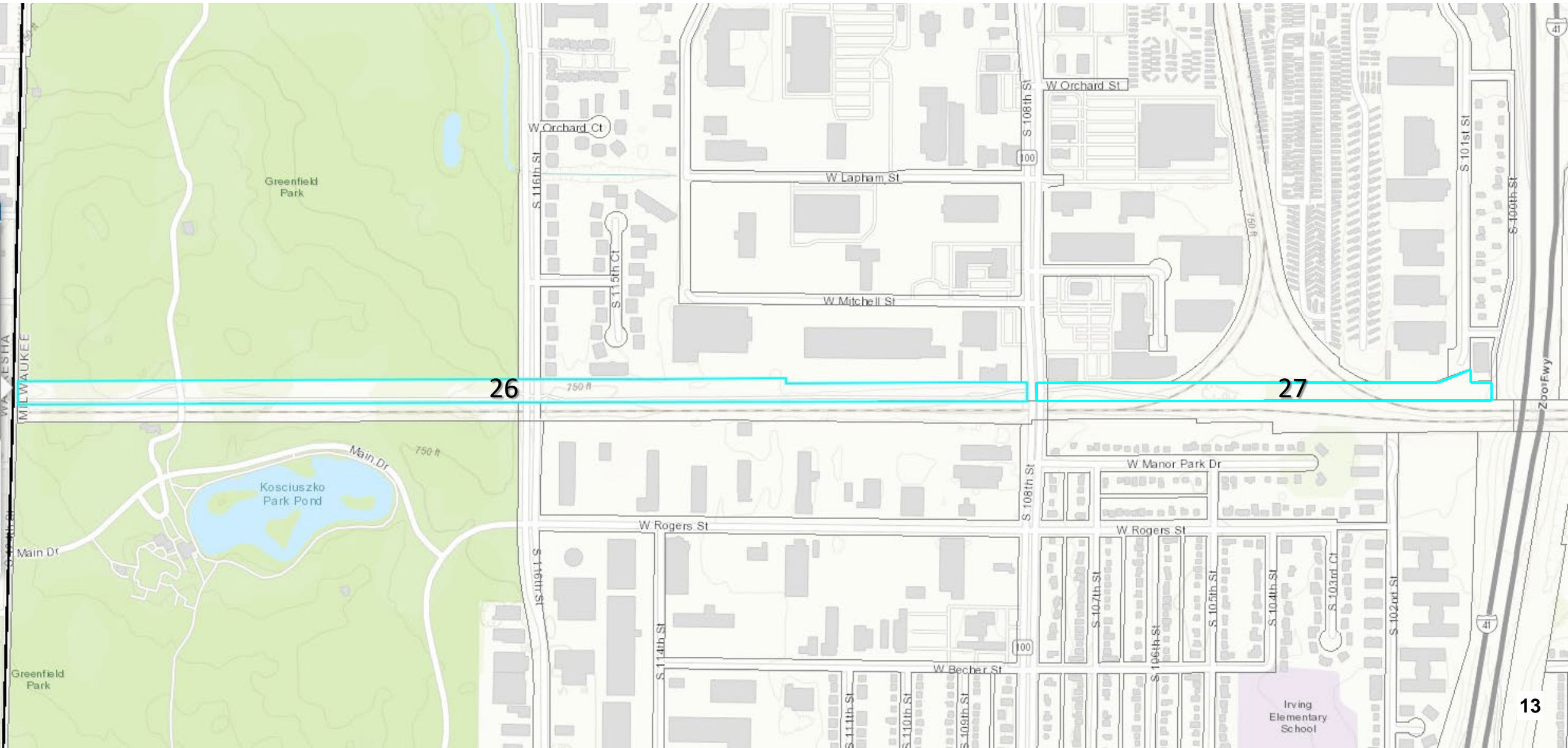

Mitchell St

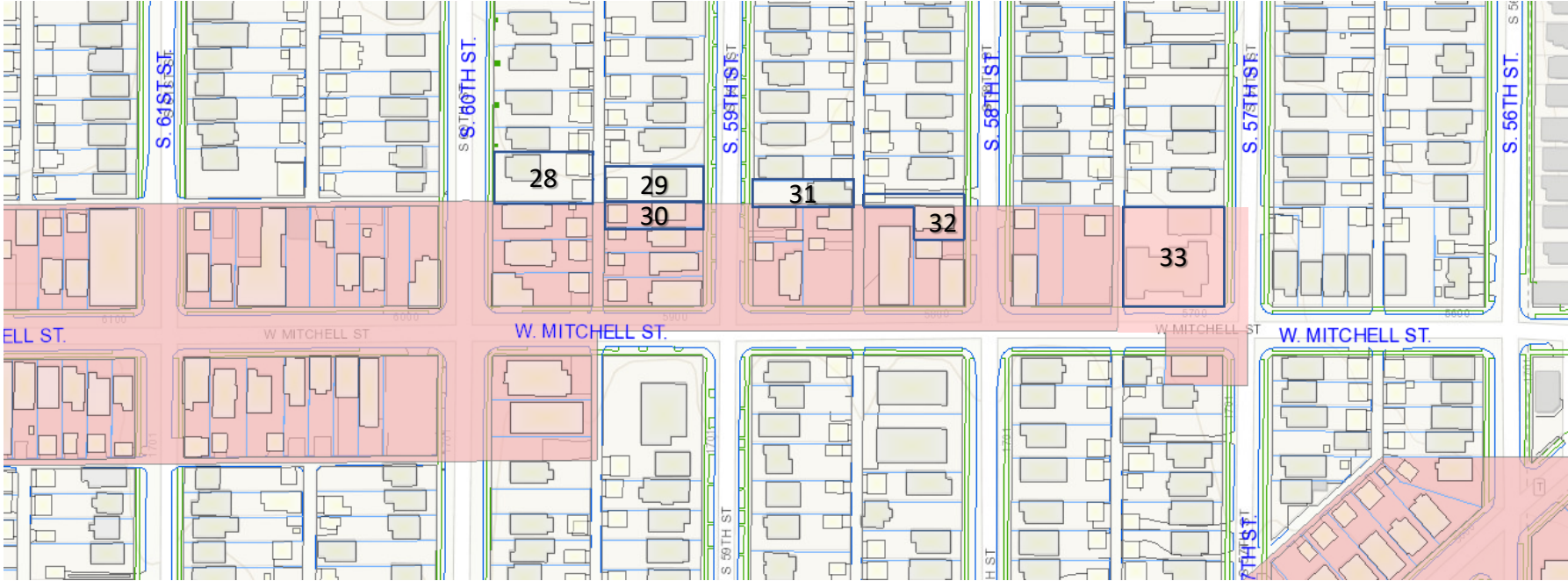

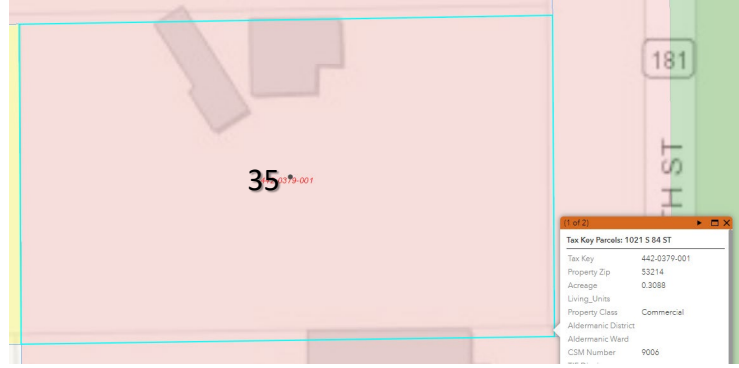
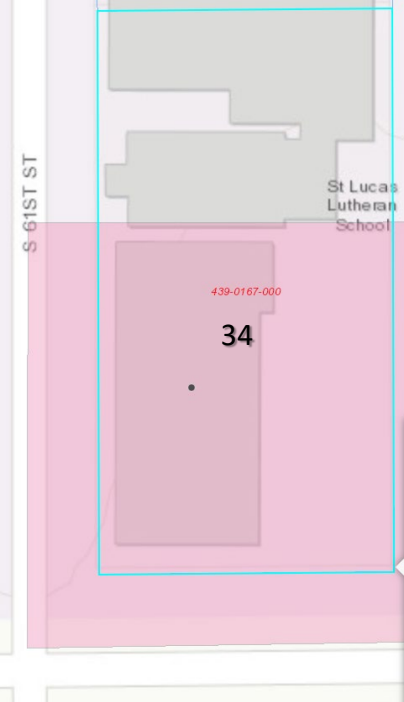

Tax Key Parcels: 1021 S 84 ST	
Tax Key	440-0379-001
Property Zip	53214
Acres	0.3088
Living Units	
Property Class	Commercial
Aldermanic District	
Aldermanic Ward	
CSM Number	9006

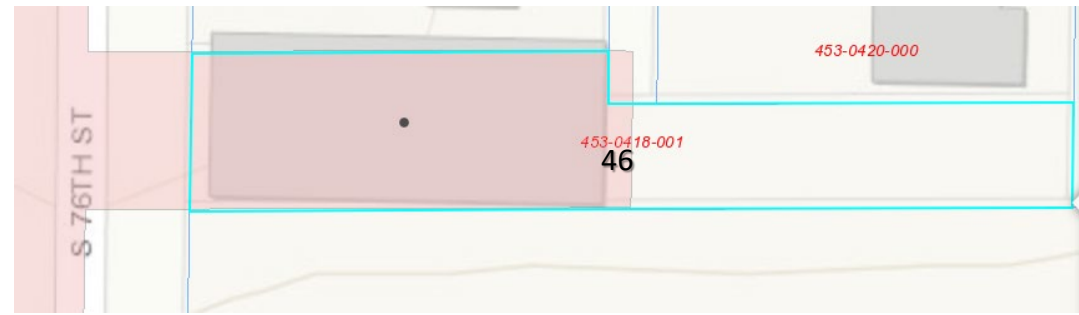
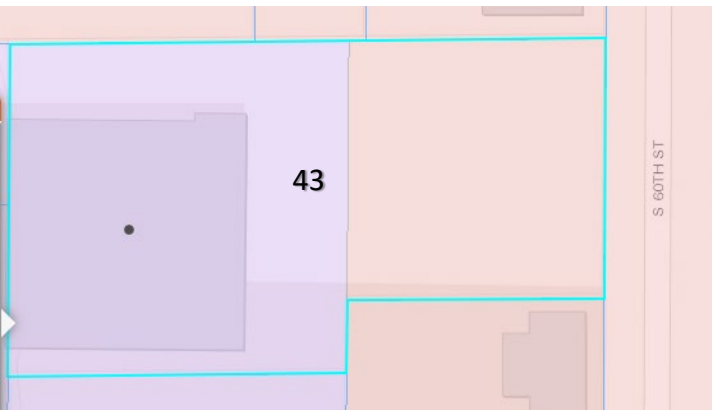
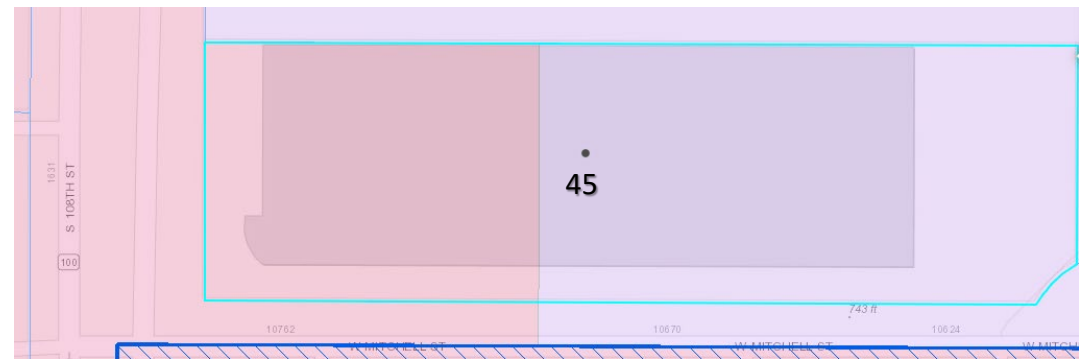
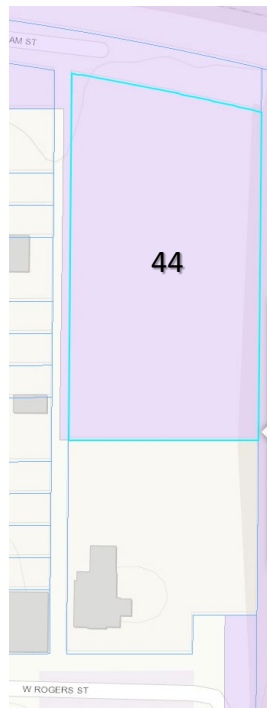
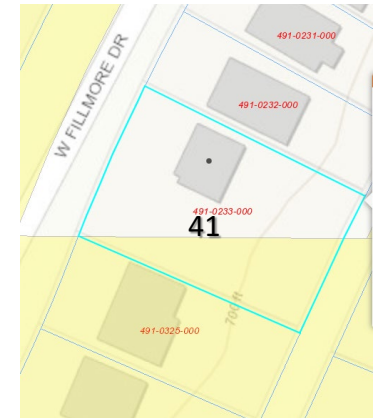
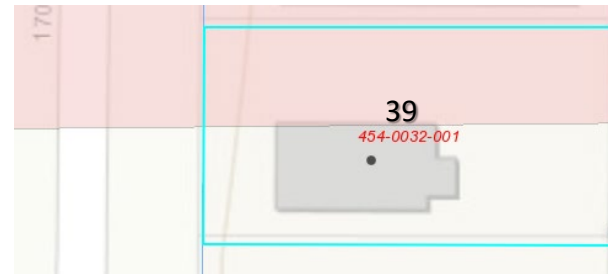
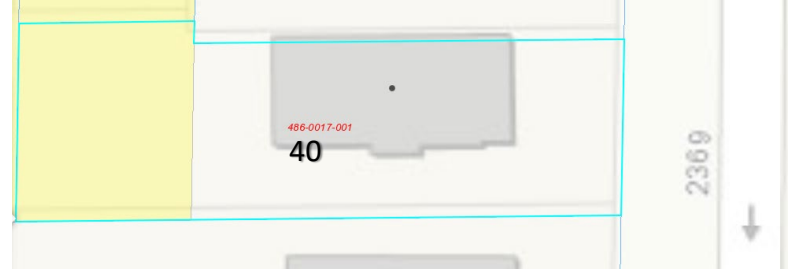
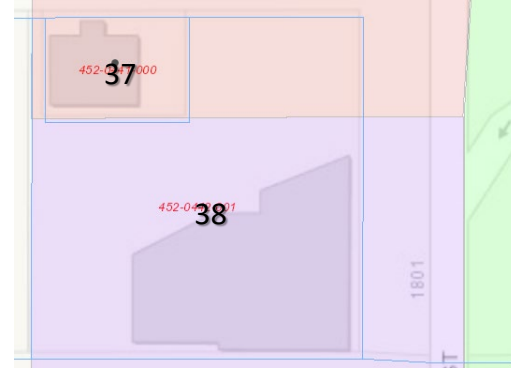
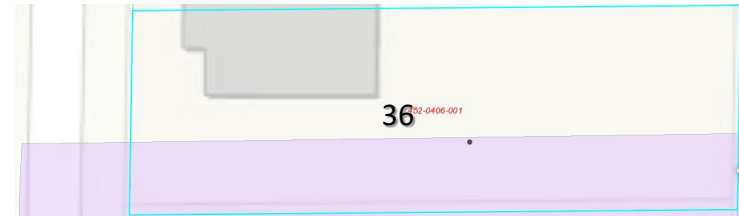
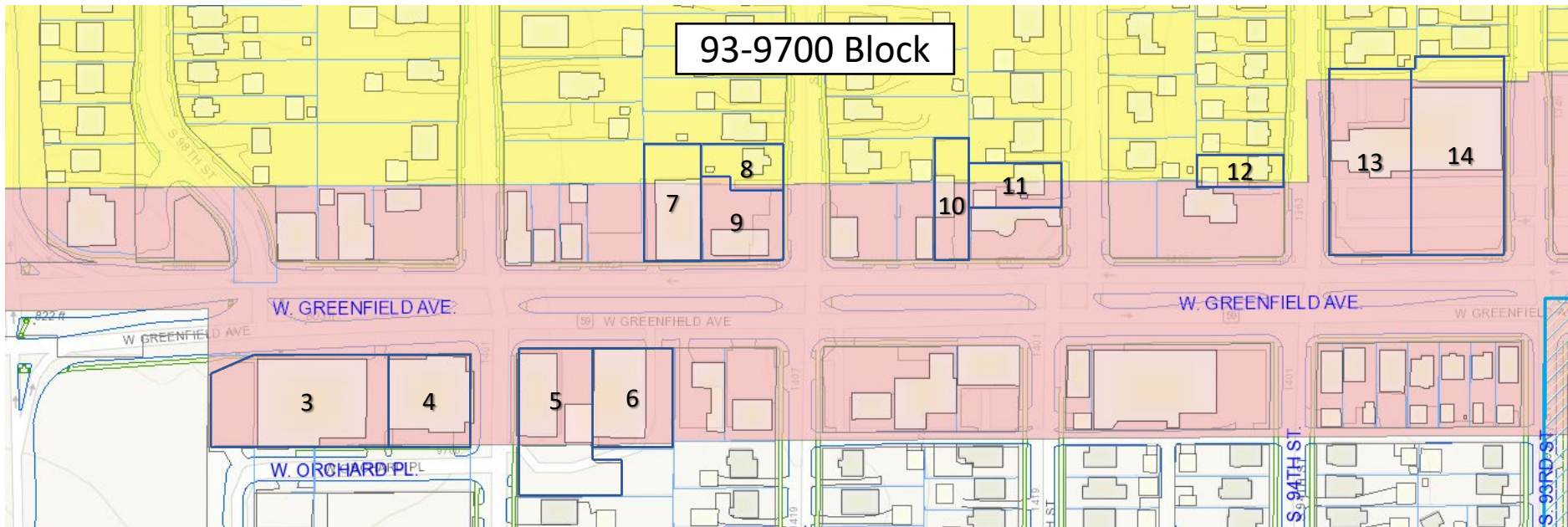
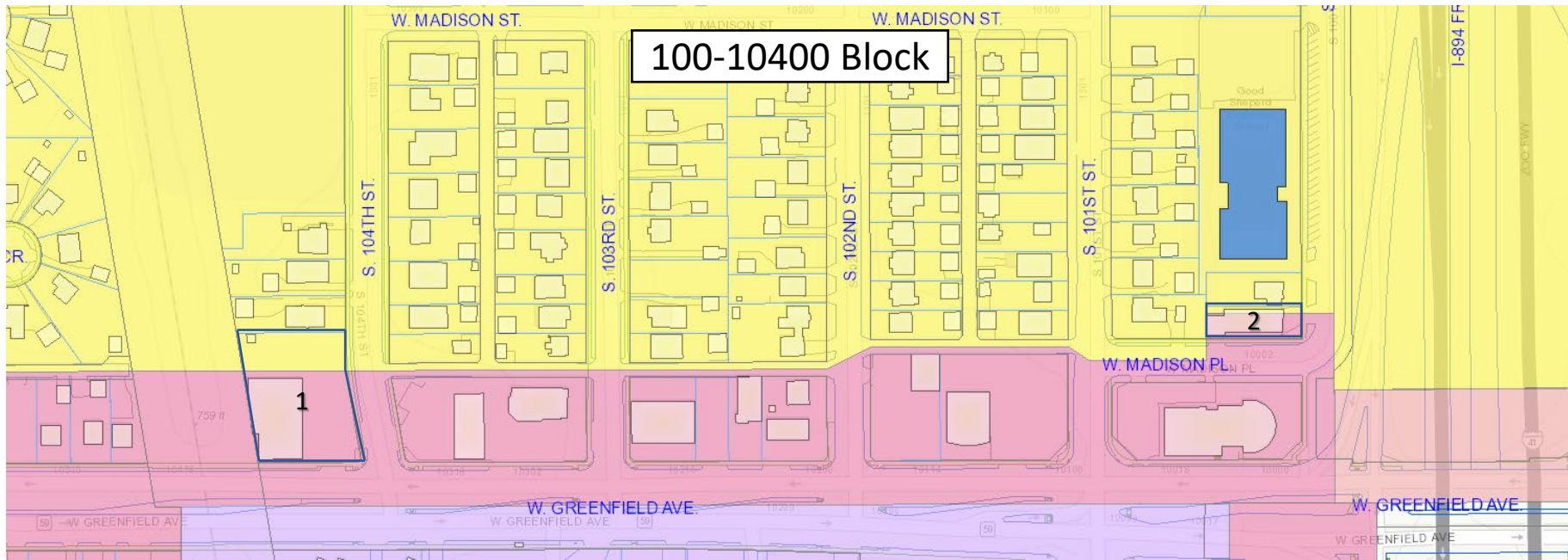
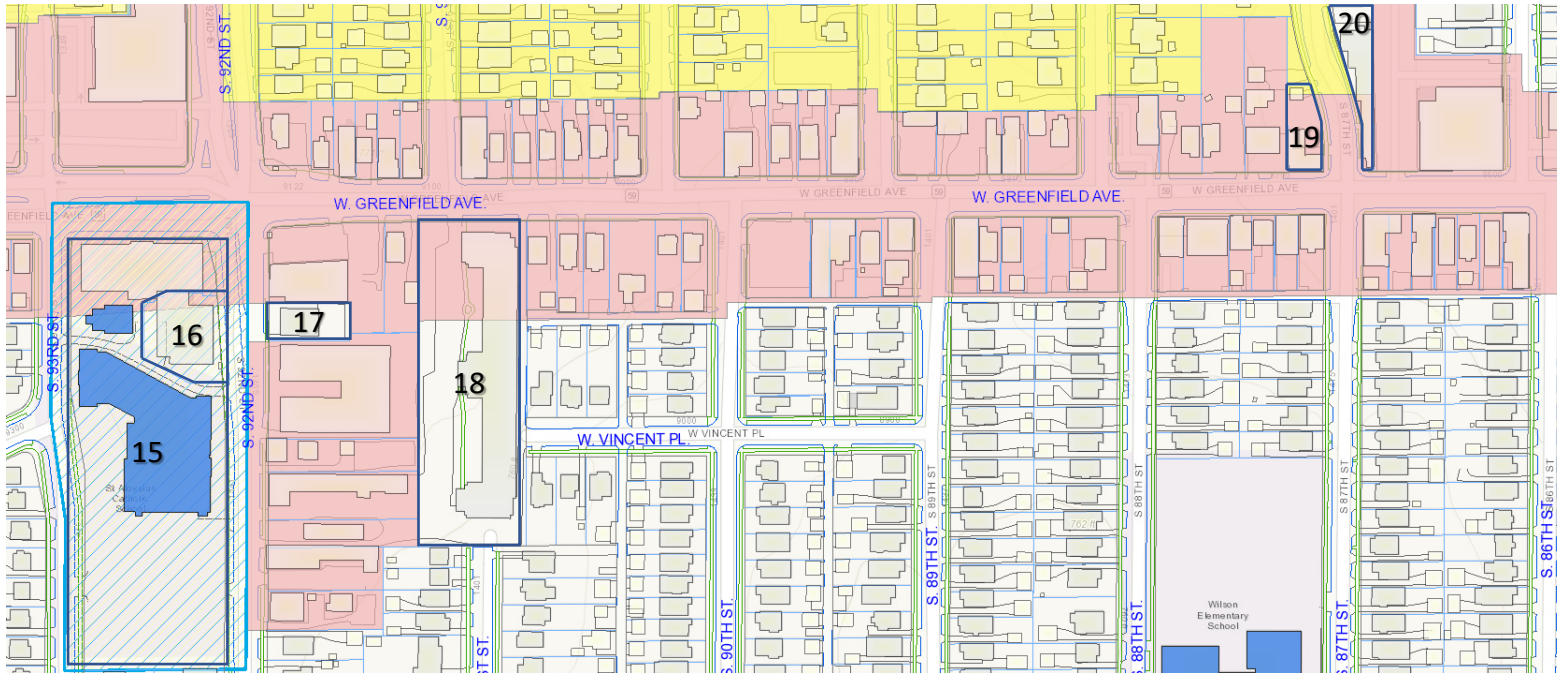

Exhibit A - Greenfield Ave. Corridor Rezoning

Map ID	Address	Taxkey	Existing Zoning	Proposed Zoning
1	10414 W GREENFIELD AVE	444-0357-002	C-3, RA-3	C-3
2	1355 S 100 ST - 10004 W MADISON PL	444-0541-002	C-3, RA-3	C-3
3	9719-21-33 W GREENFIELD AVE	450-0131-002	C-2, RB	C-2
4	9701-09 W GREENFIELD AVE	450-9965-001	C-2, RB	C-2
5	9633 W GREENFIELD AVE	450-9953-001	C-2, RB	C-2
6	9617-17A W GREENFIELD AVE	450-9951-001	C-2, RB	C-2
7	9618-20 W GREENFIELD AVE	443-0271-001	C-2, RA-3	C-2
8	1365 S 96 ST	443-0272-002	C-2, RA-3	RA-3
9	9600 W GREENFLD AVE - 1383 S 96 ST	443-0272-005	C-2, RA-3	C-2
10	9518 W GREENFIELD AVE	443-0216-000	C-2, RA-3	C-2
11	1361 S 95 ST	443-0218-000	C-2, RA-3	RA-3
12	1361 S 94 ST	443-0161-000	C-2, RA-3	RA-3
13	9330 W GREENFIELD AVE	443-0131-006	C-2, RA-3	C-2
14	9306 W GREENFIELD AVE	443-0131-007	C-2, RA-3	C-2
15	1405-35-41 S 92 ST - 1414 S 93 ST	450-0502-000	C-2, RB	RC
16	1415 S 92 ST	450-0501-000	C-2, RB	RC
17	1416 S 92 St	451-0225-000	RB	C-2
18	9047 W GREENFIELD AVE	451-0220-003	C-2, RB	RC
19	8700-2 W GREENFLD AVE - 1369 S 87 ST	442-0594-001	C-2, RA-3	C-2
20	8626-26A W GREENFIELD AVE - 1370 S 87 ST	442-0593-004	C-2, RB	C-2
21	7525 W GREENFIELD AVE	453-0340-002	C-1, RB	C-1
22	13** S 74 ST	440-0423-002	C-1, RB	C-1



86-9200 Block



74-7500 Block

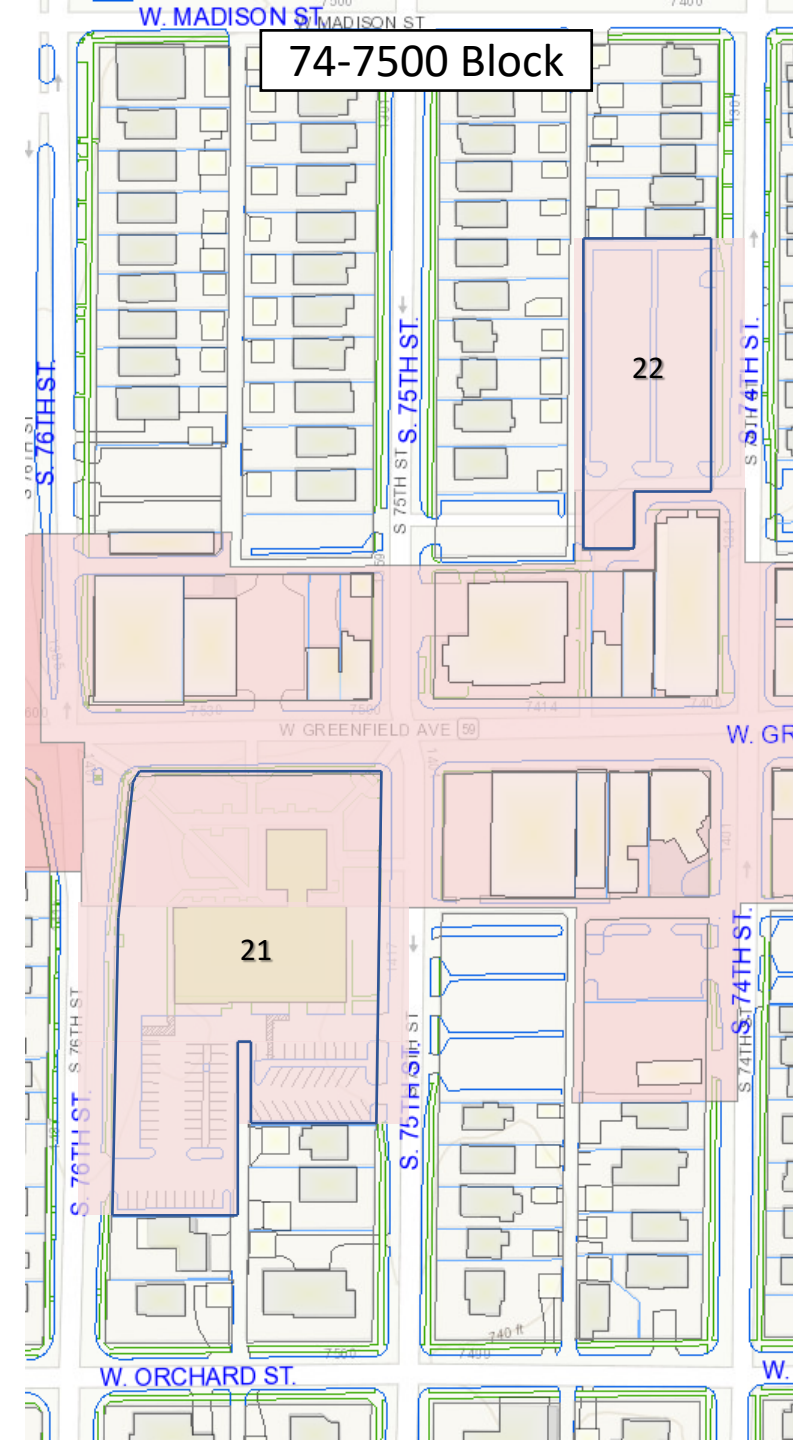

CITY OF WEST ALLIS

ORDINANCE O-2022-0163

ORDINANCE TO AMEND SECTION 19.01, THE OFFICIAL WEST ALLIS ZONING MAP, FOR CERTAIN PROPERTIES IN ALIGNMENT WITH THE 2040 COMPREHENSIVE PLAN.

AMENDING ZONING MAP

WHEREAS, for the purpose of promoting the health, safety, morals or the general welfare of the community, the common council may divide the city into districts of such number, shape, and area as may be deemed best suited to carry out the purposes of Wis. Stat.62.23; and

WHEREAS, the council finds that the amendments within this ordinance shall be in accordance with the comprehensive plan; and

WHEREAS, the amendments within this ordinance have been submitted to the city plan commission for recommendation and report, published as a class 2 notice, and the subject of a public hearing;

NOW THEREFORE, the common council of the City of West Allis do ordain as follows:

The zoning map is hereby amended to rezone the subject properties (inclusive of adjacent right-of-way), in alignment with the 2040 comprehensive plan. The subject properties are described in **Exhibit A – List Rezoning**s.

SECTION 1: AMENDMENT “19.01 Zoning Map” of the City of West Allis Municipal Code is hereby amended as follows:

A M E N D M E N T

19.01 Zoning Map

The locations and boundaries of the zoning districts in the City are established and set forth on the Official Zoning Map. The map may be amended by the common council pursuant to Wis. Stat. 62.23. The current Official Zoning Map shall be kept on file in the office of the City Clerk and shall be available for inspection by the public during normal City Hall hours of operation. Unless otherwise indicated in relation to established lines, points or features, the zoning district boundary lines on the Official Zoning Map are the City limit lines; center lines of streets, highways, alleys or railroad right-of-way, existing or extended; and, tract or lot lines, existing or extended.

The Official West Allis Zoning Map will be updated to reflect changes with the passage of this ordinance.

SECTION 2: EFFECTIVE DATE This Ordinance shall be in full force and effect on and after the required approval and publication according to law.



City of West Allis Meeting Minutes Common Council

Mayor Dan Devine, Chair

Alderson Thomas G. Lajsic, Council President

*Aldersons: Suzzette Grisham, Kevin Haass, Danna Kuehn, Thomas G. Lajsic, Rosalie L. Reinke,
Daniel J. Roadt, Tracy Stefanski, Vincent Vitale, and Martin J. Weigel*

Tuesday, November 1, 2022

7:00 PM

City Hall, Common Council Chambers
7525 W. Greenfield Avenue

REGULAR MEETING

A. CALL TO ORDER

Mayor Devine called the meeting to order at 7:00 p.m.

B. ROLL CALL

Present 9 - Grisham, Haass, Kuehn, Lajsic, Reinke, Roadt, Stefanski, Vitale, and Weigel

C. PLEDGE OF ALLEGIANCE

Led by Ald. Reinke.

D. PUBLIC HEARINGS

1. [R-2022-0774](#) Resolution to repeal and replace the Planning Department's Site, Landscaping, and Architectural Plan Design Review Guidelines.

Sponsors: Safety and Development Committee

Planner, Zac Roder presented.

2. [2022-1002](#) 2023 City of West Allis Mayor's Recommended Budget.

Administrator/Clerk Rebecca Grill and Finance Director Jason Kaczmarek presented.

Jim Nickel, 813 S 87th St., spoke about the budget and questioned ERP regulations.

Discussion Purposes Only

E. CITIZEN PARTICIPATION

None.

F. ANNOUNCEMENT OF RECESS MEETINGS OF STANDING COMMITTEES

Mayor Devine announced that the following Standing Committees would meet during recess: Safety & Development and License & Health.

G. MAYOR'S REPORT

Mayor Devine thanked staff and planners for Honey Creek success and spoke about early voting hours.

H. ALDERPERSON'S REPORT

Ald. Grisham acknowledged great neighbors in Conrad & Rainbow Gardens getting together and thanked Steve Schaer and Danielle Carrington.

I. APPROVAL OF MINUTES

- 3. [2022-1069](#) October 18, 2022 Draft Common Council Minutes.

Ald. Lajsic moved to approve, Ald. Stefanski seconded, motion carried.

J. ITEMS NOT REFERRED TO COMMITTEE (CONSENT AGENDA)

Passed The Consent Vote

Ald. Lajsic moved to approve the Consent Agenda, items #4 - #14, motion carried by roll call vote:

Aye: 9 - Grisham, Haass, Kuehn, Lajsic, Reinke, Roadt, Stefanski, Vitale, and Weigel

No: 0

- 4. [O-2022-0160](#) Ordinance updating night parking regulations.

Sponsors: Alderperson Haass

Passed

- 5. [O-2022-0162](#) Ordinance designating city engineer as an official authorized to issue and be named in citations or complaints.

Sponsors: Alderperson Roadt

Passed

- 6. [R-2022-0763](#) Resolution authorizing the purchase of ballistic vests and tactical helmets for the West Allis Police Department SWAT Team for an amount not to exceed \$81,000.

Adopted

- 7. [R-2022-0765](#) Resolution to authorize the purchase of one 2023 Volvo L70H Wheel Loader from Aring Equipment Company for a total sum of \$191,452.

Sponsors: Public Works Committee

Adopted

- 8. [R-2022-0766](#) Resolution to accept the proposals of Ewald Automotive Group and Casper's Truck Equipment for furnishing and delivering one 2023 Ford F-250 4x4 pick-up truck for \$44,529.50 and one Western MVP3 8'6" snow plow package for \$8,682 for a total sum of \$53,211.50.

Sponsors: Public Works Committee

Adopted

9. [R-2022-0767](#) Resolution to accept the proposals of Ewald Automotive Group and Casper's Truck Equipment for furnishing and delivering one 2023 Ford F-450 DRW 60"CA 4WD truck for \$49,184.50 and one Henderson Mark III Dump Body, one Western MVP3 9'6" snow plow package, and one SnowEx Helixx Material Spreader for \$36,351 for a total sum of \$85,535.50.

Sponsors: Public Works Committee

Adopted

10. [R-2022-0768](#) Resolution to accept the proposals of Ewald Automotive Group and Casper's Truck Equipment for furnishing and delivering one 2023 Ford F-450 DRW 84"CA 4WD truck for \$49,839.50 and one Henderson Mark III Dump Body with maintainer package, and one Western MVP3 9'6" snow plow package, for \$46,884 for a total sum of \$96,723.50.

Sponsors: Public Works Committee

Adopted

11. [R-2022-0776](#) Resolution approving a six-month extension of time to commence State Fair Petro Mart, a proposed fuel sales and retail use, to be located at 2904 S. 84th Street submitted by Gurinder S. Nagra (Tax Key No. 516-9988-001).

Sponsors: Safety and Development Committee

Adopted

12. [R-2022-0777](#) Resolution approving a six-month extension of time to commence State Fair Petro Mart, a proposed fuel sales and retail use, to be located at 8404 W Greenfield Ave. submitted by Gurinder S. Nagra (Tax Key No. 442-9001-000).

Sponsors: Safety and Development Committee

Adopted

13. [2022-1058](#) Class B Tavern Temporary Premise Extension request for a one-day event for John Starr, d/b/a Broken Starr Saloon, 1100 S. 60th St. on November 5, 2022. (TEMP 22 27)

Granted

14. [2022-1068](#) Reappointment by Mayor Devine of John Zentgraf to the Commission on Aging, with a 3-year term to expire November 1, 2025.

Approved

K. COMMON COUNCIL RECESS

Ald. Lajsic moved that the Council recess until completion of the Standing Committee meetings, Ald. Reinke seconded, motion carried.

The Council recessed at 7:43 p.m. and returned at 8:05 p.m.

Roll Call was taken and the following were present:

Present 9 - Grisham, Haass, Kuehn, Lajsic, Reinke, Roadt, Stefanski, Vitale & Weigel.

L. NEW AND PREVIOUS MATTERS

ADMINISTRATION & FINANCE COMMITTEE

None.

PUBLIC WORKS COMMITTEE

None.

SAFETY & DEVELOPMENT COMMITTEE

Passed The Block Vote

Ald. Lajsic moved to approve the actions on items #15 - #16, motion carried by roll call vote:

Aye: 9 - Grisham, Haass, Kuehn, Lajsic, Reinke, Roadt, Stefanski, Vitale, and Weigel

No: 0

- 15. [R-2022-0774](#) Resolution to repeal and replace the Planning Department's Site, Landscaping, and Architectural Plan Design Review Guidelines.

Sponsors: Safety and Development Committee

Committee Action:

Ald. Kuehn moved to pass, Ald. Haass seconded, motion carried.

Council Action: Adopted

- 16. [R-2022-0775](#) Resolution to approve a Commercial Facade Improvement Project Contract by and between the City of West Allis and John and Diane Knecht, property owners for the property located at 5801-03 W. National Ave. and 1331 S. 58 St., in the amount not to exceed \$30,000.

Committee Action:

Ald. Haass moved to pass, Ald. Weigel seconded, motion carried.

Meeting Adjourned at 7:49 p.m.

Council Action: Adopted

LICENSE & HEALTH COMMITTEE

2022-2024 Operator's License (Bartender/Class D Operator) Applications

- 17. [2022-1030](#) NEW - BART 382 - Abimael Torres Garcia.
Held due to non-appearance at October 18, 2022 License & Health meeting.

Committee Action:
Ald. Stefanski moved to Deny due to non-appearance and background check Ald. Reinke seconded, motion carried.

Council Action: Denied

Liquor License Applications

- 18. [2022-1027](#) New Class B Tavern and Public Entertainment Permit for KARMAREB LLC, d/b/a Karma, 7033 W. Becher Street. Agent: Rebecca A Hagmann. (ALC 22 209)

Committee Action:
Ald. Stefanski moved to Grant Ald. Grisham seconded, motion carried.

Council Action: Granted

- 19. [2022-1044](#) New Class A Liquor & Beer for Taylor’s Wine & Spirits LLC, d/b/a Taylor’s Wine & Spirits, 1568 S. 81st Street. Agent: Keith Carter. (ALC 22 210)

Committee Action:
Ald. Reinke moved to Deny Ald. Grisham seconded, motion carried.

Meeting adjourned at 8:03 p.m.

Council Action: Denied

Ald. Vitale moved to approve the actions on items #17 - #19, motion carried by roll call vote:

Aye: 9 - Grisham, Haass, Kuehn, Lajsic, Reinke, Roadt, Stefanski, Vitale, and Weigel

No: 0

ADVISORY COMMITTEE

None.

M. ADJOURNMENT

Ald. Lajsic moved to adjourn at 8:06 p.m., Ald. Grisham seconded, motion carried.

Next scheduled meeting is November 15, 2022 at 7:00 p.m.

YouTube Meeting Links for November 1, 2022:

Common Council Part 1

<https://www.youtube.com/watch?v=oXcv65dElmg&t=2138s>

Recess - Safety & Development

<https://www.youtube.com/watch?v=Z1ky79J-je4>

Recess - License & Health

<https://www.youtube.com/watch?v=NVEzR5LeQL0>

Common Council Part 2

https://www.youtube.com/watch?v=nbi7fG_qn1k



All meetings of the {bdName} are public meetings. In order for the general public to make comments at the committee meetings, the individual(s) must be scheduled (as an appearance) with the chair of the committee or the appropriate staff contact; otherwise, the meeting of the committee is a working session for the committee itself, and discussion by those in attendance is limited to committee members, the mayor, other alderpersons, staff and others that may be a party to the matter being discussed.

NON-DISCRIMINATION STATEMENT

The City of West Allis does not discriminate against individuals on the basis of race, color, religion, age, marital or veterans' status, sex, national origin, disability or any other legally protected status in the admission or access to, or treatment or employment in, its services, programs or activities.

AMERICANS WITH DISABILITIES ACT NOTICE

Upon reasonable notice the City will furnish appropriate auxiliary aids and services when necessary to afford individuals with disabilities an equal opportunity to participate in and to enjoy the benefits of a service, program or activity provided by the City.

LIMITED ENGLISH PROFICIENCY STATEMENT

It is the policy of the City of West Allis to provide language access services to populations of persons with Limited English Proficiency (LEP) who are eligible to be served or likely to be directly affected by our programs. Such services will be focused on providing meaningful access to our programs, services and/or benefits.

**CITY OF WEST ALLIS
ORDINANCE O-2022-0165**

**ORDINANCE AUTHORIZING THE USE OF NO-TRESPASS ORDERS AT ALL
CITY PARKS**

AMENDING SECTION 6.09

WHEREAS, the common council seeks to update WAMC 6.09 to reflect the locations treated as parks for the purpose of the law authorizing no-trespass orders;

NOW THEREFORE, the common council of the City of West Allis do ordain as follows:

SECTION 1: **AMENDMENT** “6.09 No Trespass Orders For City Parks” of the City Of West Allis Municipal Code is hereby *amended* as follows:

AMENDMENT

6.09 No Trespass Orders For City Parks

1. Definitions. As used in this section.

a. "Parks" means any and all the following locations: ~~lands that are designated as City parks or playgrounds within the City of West Allis, including Garfield School, Honey Creek, Klentz, Kopperud, Liberty Heights, North Greenfield Railroad Station Park, Joyce Radtke, Reservoir, Rogers and Veterans' Housing and Memorial Parks; and McKinley Park, Rogers, and Washington playgrounds.~~

- i. Arnold Klentz Park (2601 South 72 Street)
- ii. Burnham Pointe Park (6031 West Burnham Street)
- iii. Honey Creek Park (1999 South 84 Street)
- iv. Joyce Radtke Skate Park (8320 West National Avenue)
- v. Kopperud Park (South 76 Street and West Pierce Street)
- vi. Liberty Heights Park (1540 South 62 Street)
- vii. Mini Park (South 58 Street and West Beloit Road)
- viii. Mini Park (South 60 Street and West National Avenue)
- ix. Railroad Park (West National Avenue and South 82 Street)
- x. Reservoir Park (9621 West Lapham Street)
- xi. Rogers Park '(2023 South 75 Street)
- xii. Rogers Playground (2014 South 56 Street)
- xiii. Roosevelt Park (938 South 58 Street)
- xiv. Veterans Memorial Park (West National Avenue and South 70 Street)
- xv. West Allis Dog Park (11200 West Hayes Avenue)
- xvi.

West Allis Farmer's Market (6501 West National Avenue)

- b. "Assault" means any intentional act to harmfully or offensively contact another person, including attempts or threats.
 - c. "Sexual act" means any act of masturbation, sexual gratification, sexual intercourse, physical contact with or exposure of a person's genital or pubic area, buttocks, or, if the person is a female, breast (excluding a mother breast-feeding a child).
2. Authority. The Police Department has the authority to issue and serve no trespass orders informing the recipient that he or she is prohibited from entering or remaining in or upon any or all City parks.
 3. An officer may issue an order to a person if:
 - a. Said person has received a municipal citation for an incident that occurred in a park; or
 - b. A police officer has probable cause to believe said person has done one (1) or more of the following while in a park:
 - i. Committed an assault on another person;
 - ii. Sold or consumed alcohol;
 - iii. Sold, possessed, or used illegal drugs;
 - iv. Brandished or used any weapon, excluding bats or other devices used during a sporting event in the context of a game;
 - v. Caused damage, including graffiti, to any park property;
 - vi. Committed a sexual act;
 - vii. Acted in a violent, indecent, profane, abusive, unreasonably loud, or otherwise disorderly manner.
 4. Order must be in writing. All orders shall be in writing and contain the following elements:
 - a. The name of the prohibited person;
 - b. The signature of the issuing police officer;
 - c. The date of issuance;
 - d. The reason for issuance;
 - e. The duration of the order, up to one (1) year;
 - f. A list of the prohibited park(s);
 - g. Notice of the penalties for an act in violation of the order; and
 - h. Notice of the right to appeal the order's issuance.
 5. Appeal. A recipient of a no trespass order may appeal issuance or terms of the order by submitting a written appeal to the City Clerk.
 - a. Such appeal shall be in writing, and shall be filed with the City Clerk within ten (10) calendar days of issuance of the no trespass order.
 - b. Hearing. The Public Works Committee shall hold a hearing to make a final determination of the validity of the no trespass order.
 - i. The City Clerk shall notify the appellant and the City Attorney of the hearing date, time, and location, and shall schedule the hearing no more than thirty (30) days after the appeal is filed.
 - ii. Proof of a conviction in municipal or circuit court from the incident that led to the issuance of the no trespass order shall be sufficient

cause to uphold the issuance of the no trespass order.

- 6. Penalty. Any person who violates any provision in this section shall, upon conviction, pay a forfeiture not to exceed five hundred dollars (\$500.), together with the costs of prosecution, and upon default of payment thereof, shall be imprisoned in the House of Correction until such forfeiture and costs are paid, but not more than the number of days set forth in Wis. Stats. § 800.095(4). Each and every day of violation constitutes a separate offense.

[Ord. O-2012-0038, 9/18/2012]

SECTION 2: **EFFECTIVE DATE** This Ordinance shall be in full force and effect on and after the required approval and publication according to law.

PASSED AND ADOPTED BY THE CITY OF WEST ALLIS COUNCIL

_____.

	AYE	NAY	ABSENT	ABSTAIN
Ald. Vince Vitale	_____	_____	_____	_____
Ald. Tracy Stefanski	_____	_____	_____	_____
Ald. Marty Weigel	_____	_____	_____	_____
Ald. Suzzette Grisham	_____	_____	_____	_____
Ald. Danna Kuehn	_____	_____	_____	_____
Ald. Thomas Lajsic	_____	_____	_____	_____
Ald. Dan Roadt	_____	_____	_____	_____
Ald. Rosalie Reinke	_____	_____	_____	_____
Ald. Kevin Haass	_____	_____	_____	_____

Attest

Presiding Officer

Rebecca Grill, City Clerk, City Of West Allis

Dan Devine, Mayor, City Of West Allis

**CITY OF WEST ALLIS
ORDINANCE O-2022-0166**

**ORDINANCE AMENDING PLACEMENT RULES FOR FACILITIES LOCATED IN
THE RIGHT-OF-WAY**

AMENDING SECTION 11.20

WHEREAS, Wis. Stat. 66.0414(3)(c)4. allows cities to adopt aesthetic requirements governing the deployment of small wireless facilities and associated antenna equipment and utility poles in the right-of-way; and

WHEREAS, this amendment is seeking to avoid unsightly or out-of-character facility deployments in the right-of-way;

NOW THEREFORE, the common council of the City of West Allis do ordain as follows:

SECTION 1: **AMENDMENT** “11.20 Requirements For Facilities In Right-Of-Way” of the City Of West Allis Municipal Code is hereby *amended* as follows:

A M E N D M E N T

11.20 Requirements For Facilities In Right-Of-Way

Unless compliance is technically infeasible or inconsistent with state law in a particular application, any infrastructure deployments in the right-of-way shall comply with the following requirements:

1. **Compatible Color.** Each new or modified facility and all related components must be compatible in color and shape to similar facilities in the immediate area and must minimize the physical and visual impact on the area.
2. **Antenna Shroud.** Each small wireless facility antenna shall be located entirely within a shroud or enclosure that minimizes the physical and visual impact on the area.
3. **No Pruning.** No new facility may be installed in a manner that requires the removal or pruning of trees, shrubs or any plants other than turf grass.
4. **Wire Concealment.** All cables, wires, and connectors related to a facility must be concealed within a facility, conduit, or similar enclosure that is similar in color to adjacent structures or components. .
5. **Background Colors.** Any small wireless facility or unconcealed cables, wires, and connectors shall match the color of the background upon which they are attached. In the case of existing wood poles, finishes of conduit shall be zinc, aluminum or stainless steel, or colored to match those metal finishes and equipment cabinets shall be the color of brushed aluminum.

6. Owner Identification. Any small wireless facility owner shall post its name, location identifying information, and emergency telephone number in an area on the cabinet of the small wireless facility that is visible to the public. Signage required under this section shall not exceed 4 inches x 6 inches, unless otherwise required by law (e.g. RF ground notification signs) or the City. If no cabinet exists, the signage shall be placed at the base of the utility pole that supports the small wireless facility.
7. Logos/Decals: The small wireless facility owner shall remove or paint over unnecessary equipment manufacturer decals. The color shall match the surface color. Small wireless facilities and wireless support structures shall not include advertisements and may only display information required by a federal, state or local agency. The small wireless facility operator/permittee shall utilize the smallest and lowest visibility radio-frequency (RF) warning sticker required by government or electric utility regulations. Placement of the RF sticker shall be as close to the antenna as possible.
8. Cooling Fans: In residential areas, the small wireless facility owner shall use a passive cooling system. In the event that a fan is needed, the small wireless facility owner shall use a cooling fan with a low noise profile.
9. Support Equipment: Enclosures and cabinets, including electric meters, shall be as small as possible. Ground-mounted equipment shall incorporate concealment elements into the proposed design matching color and materials of the wireless support structure unless other materials or colors are approved by the City. Concealment may include, but shall not be limited to, landscaping, strategic placement in less obtrusive locations and placement within existing or replacement street furniture.
10. Placement Requirements: All facilities, including small wireless facilities and support equipment, shall be located in accordance with the following:
 - a. Small cell wireless facilities and wireless support equipment structures shall be located at least 250 feet away, radially, from another small cell wireless facility and wireless support equipment structure.
 - b. Placement shall be in a manner that does not impede, obstruct, or hinder usual public pedestrian or vehicular travel or public safety on a right-of-way.
 - c. Placement shall be in a manner that does not obstruct the legal use of a right-of-way by a utility provider.
 - d. Placement shall be in a manner that does not negatively impact the structural integrity of the associated wireless support equipment structure.
 - e. Placement shall be in alignment with existing trees, utility poles, and streetlights.
 - f. Placement shall be equal distance between trees when possible, with a minimum of 15 feet separation such that no proposed disturbance shall occur within the critical root zone of any tree.
 - g. Placement shall be with appropriate clearance from existing utilities including privately owned water services, privately owned sanitary sewer laterals and privately owned storm sewer laterals.
 - h. Placement shall be along the secondary property street frontage (side yards). If this is not possible some small cell facilities may be placed in the ROW in

front of single family or two family residential properties only at the intersection of property lines or equidistance from any two existing structures so as not to significantly create a new obstruction to property sight lines. The facilities shall not be installed between the perpendicular extensions of the primary street-facing wall plane of any single or two-family residence.

- i. In areas of the City where multiple structures abut each other, new facilities shall not be located directly in front of an entrance or window of any existing structure.
- j. Placement shall not be within sight triangles at street intersections.
- k. Placement shall be 10 feet away from the triangle extension of an alley way flare.
- l. Wireless support equipment structures shall be located as close as practicable to a utility pole or wireless support structure.

SECTION 2: EFFECTIVE DATE This Ordinance shall be in full force and effect on and after the required approval and publication according to law.

PASSED AND ADOPTED BY THE CITY OF WEST ALLIS COUNCIL

	AYE	NAY	ABSENT	ABSTAIN
Ald. Vince Vitale	_____	_____	_____	_____
Ald. Tracy Stefanski	_____	_____	_____	_____
Ald. Marty Weigel	_____	_____	_____	_____
Ald. Suzzette Grisham	_____	_____	_____	_____
Ald. Danna Kuehn	_____	_____	_____	_____
Ald. Thomas Lajsic	_____	_____	_____	_____
Ald. Dan Roadt	_____	_____	_____	_____
Ald. Rosalie Reinke	_____	_____	_____	_____
Ald. Kevin Haass	_____	_____	_____	_____

Attest

Presiding Officer

Rebecca Grill, City Clerk, City Of West Allis

Dan Devine, Mayor, City Of West Allis

**CITY OF WEST ALLIS
RESOLUTION R-2022-0643**

**RESOLUTION TO APPROVE AN INCREASE IN THE ECONOMIC
DEVELOPMENT LOAN ASSISTANCE TO OPE BREWING COMPANY, LLC AND
WEST ALLIS BREWING PROPERTY, LLC TO ASSIST WITH INCREASED
COSTS AND ADDITIONAL EQUIPMENT FOR THE ESTABLISHMENT OF A
BREWERY AND ENTERTAINMENT VENUE AT 6749-51 W. NATIONAL AVENUE**

WHEREAS, the Community Development Authority of the City of West Allis (the “Authority”) approved the sale of land to Ope Brewing Company, LLC and West Allis Brewing Property, LLC for the establishment of a brewery and entertainment venue; and,

WHEREAS, Adam Anders, John Onopa and Kyle Ciske, owners, and members (Borrowers) , were approved for an Economic Development Loan under a Resolution No. R-2021-0154 from the City of West Allis in the amount of One Hundred Fifty Thousand Dollars and 00/100 (\$150,000); and

WHEREAS, the Borrowers have requested an increase in the economic development loan to account for increased project costs related to kitchen space and the additional equipment to help meet product demand; and,

WHEREAS, Economic Development Program is proposing an increase in the Economic Development Loan using \$50,000 from Community Development Block Grant Funds and \$50,000 from Tax Increment District # 14.

WHEREAS, the Economic Development Loan Task Force met on to consider the loan application and recommended approval of the Economic Development Loan application.

NOW THEREFORE, BE IT RESOLVED by the Common Council of the City of West Allis that it hereby approves the terms and conditions of the Loan in the amount not to exceed One Hundred and 00/100 Dollars (\$100,000) to Ope Brewing Company, LLC and West Allis Brewing Property, LLC in accordance with the terms and conditions outlined in the Commitment Letter attached as Exhibit A hereto and incorporated herein by reference.

BE IT FURTHER REVOLED the City Attorney is hereby authorized to prepare loan documents required by the aforesaid commitment.

BE IT FURTHER RESOLVED that the City Attorney be and is hereby authorized to make such non-substantive changes, modifications, additions and deletions to and from the loan documents, including any and all attachments, exhibits, addendums and amendments, as may be necessary and proper to correct inconsistencies, eliminate ambiguity and otherwise clarify and supplement said provisions to preserve and maintain the general intent thereof, and to prepare and deliver such other and further documents as may be reasonably necessary to complete the transactions contemplated therein.

BE IT FURTHER RESOLVED that the proper City Officers, or any of their authorized deputies, as necessary, are authorized on behalf of the city to execute the aforesaid loan documents.

BE IT FURTHER RESOLVED that \$100,000 will be funded from Tax Incremental Financing District Number 14 (Milwaukee Ductile Iron) and \$50,000 from the Community Development Block Grant program.

SECTION 1: **ADOPTION** “R-2022-0643” of the City Of West Allis Municipal Resolutions is hereby *added* as follows:

A D O P T I O N

R-2022-0643(*Added*)

PASSED AND ADOPTED BY THE CITY OF WEST ALLIS COUNCIL

_____.

	AYE	NAY	ABSENT	ABSTAIN
Ald. Angelito Tenorio	_____	_____	_____	_____
Ald. Vince Vitale	_____	_____	_____	_____
Ald. Tracy Stefanski	_____	_____	_____	_____
Ald. Marty Weigel	_____	_____	_____	_____
Ald. Suzzette Grisham	_____	_____	_____	_____
Ald. Danna Kuehn	_____	_____	_____	_____
Ald. Thomas Lajsic	_____	_____	_____	_____
Ald. Dan Roadt	_____	_____	_____	_____
Ald. Rosalie Reinke	_____	_____	_____	_____
Ald. Kevin Haass	_____	_____	_____	_____

Attest

Presiding Officer

Rebecca Grill, City Clerk, City Of
West Allis

Dan Devine, Mayor, City Of West
Allis



September 20, 2022

Mr. John P. Onopa, Mr. Adam R. Anders,
and Mr. Kyle E. Ciske
c/o West Allis Brewing Property LLC and
Ope Brewing Company LLC
6749-51 W. National Avenue,
West Allis, WI 53214.

Dear Mr. John P. Onopa, Mr. Adam R. Anders, and Mr. Kyle E. Ciske:

Pursuant to your application for an increased loan and information provided by you regarding the establishment of a brewery and entertainment venue located at 6749-51 W. National Avenue, 67** W. National Avenue, and 67** W. Mitchell, the Common Council of the City of West Allis ("City") hereby agrees to make a loan to you, in accordance with the following specific terms and conditions:

1. Borrower. The Borrower shall be John P. Onopa, Mr. Adam R. Anders, and Mr. Kyle E. Ciske, all owners and members of West Allis Brewing Property LLC and Ope Brewing Company, Wisconsin limited liability companies, with principal business offices at 4465 N. 100th St., Wauwatosa, WI 53225
2. Guarantor. Unlimited Personal Guarantee from John P. Onopa, Mr. Adam R. Anders, and Mr. Kyle E. Ciske.
3. Project. Loan proceeds are to be used for increased project costs and additional equipment for the establishment of Ope Brewing Company located at 6749-51 W. National Avenue.
4. Loan Amount. The loan amount shall not exceed One Hundred Thousand Dollars (\$100,000) structured as the following
 - A. \$50,000 Tax Increment Financing Loan
 - B. \$50,000 Economic Development Community Development Block Grant Loan
5. Disbursement. Disbursement will be made upon proper submittal of invoices or purchased orders. The loan will be evidenced by two notes payable by the Borrower to the City.
6. Term. The term of the loan shall be as follows:
 - A. \$50,000 Tax Increment Financing Loan will be (25) years with a 25-year amortization.
 - B. \$50,000 Economic Development Loan CDBG Loan will be a (5) year loan with a 60-month amortization.

7. Interest Rate. (to be computed on basis of 360-day year.) The interest rate shall be five and half percent (5.50%) fixed rate.
 - A. Interest payments. Commence on the first month following Closing.
 - B. Default. In the event of default, all unpaid principal and interest shall bear interest at the rate of eighteen percent (18%) per annum until paid.
8. Payments. Payments will be as follows:
 - A. \$50,000 Tax Increment Financing Loan payments will commence on the first month following closing with full payments of interest and principal payments.
 - B. \$50,000 CDBG Economic Development Loan payments will commence on the first month following closing with full payments of interest and principal payments.
 - C. Disbursement. Disbursement of the aggregate the funds will be upon paid invoice, presentation of two quotes, and/or purchase orders.
 - D. Note. The loan will be evidenced by two note payable by the Borrower to the City.
9. Late Charge. A late charge not to exceed one percent (1%) on each dollar of each payment, which is more than ten (10) days in arrears may be collected provided that no such charge shall exceed the maximum amount which may be charged according to law.
10. Security. As security for the loan, the Borrower will deliver to City:
 - i. A subordinate mortgage on the real estate at 6749-51 W. National Avenue subordinate to the financial interests of Citizens Bank and Wisconsin Business Development only.
 - ii. A General Business Security Agreement on the business assets of West Allis Brewing Property LLC and Ope Brewing Company LLC subordinate to the financial interests of Citizens Bank and Wisconsin Business Development only
 - iii. Unlimited Personal Guaranty of John P. Onopa, Adam R. Anders, and Kyle E. Ciske.
11. Loan Processing Fee. A non-refundable fee of One Thousand Dollars (\$1,000.00) to be paid upon acceptance and delivery of this Commitment. (Borrower may elect to include this fee in the terms of the note). The fee is compensation to the City for making the loan and shall be fully and completely earned upon acceptance of this Commitment by the Borrower.
12. Maturity Date. This loan shall mature as follows:
 - A. TIF LOAN: Matures on the 300th month following closing.
 - B. CDBG LOAN: Matures on the 60th month following closing.
13. Closing Date. The loan shall close on or before September 30, 2022.
14. Prepayment Privilege. The loan may be prepaid, in whole or in part, at any time without penalty or restriction.

15. Number. Borrower must provide a Duns Number and federal identification number to the City.
16. CDBG Loan Requirement - Job Creation/Retention. Borrower agrees to add three (3) full-time equivalent positions over the next two years. At least fifty-one percent (51%) of the positions are to be held by low-to-moderate income persons. A Beneficiary Reporting form is attached as **Attachment A**, that must be completed by all new hires.
 - A. General Conditions. All of the terms and conditions contained in the attached "General Conditions" (**Exhibit No. 1**) for economic development loans and "Federal Requirements" (**Attachment B**) are incorporated into this Commitment.
17. Insurance. Borrower agrees to provide proof of hazard insurance on the property and business equipment in the form of a certificate of insurance naming the City of West Allis.
18. Acceptance. Except as provided in the General Conditions, this Commitment shall be deemed binding upon if the City receives an unqualified acceptance by the Borrower of the terms and provisions contained herein, evidenced by the Borrower properly executing this document below and delivering it to the office of the undersigned on or before March 31, 2021, along with the non-refundable loan processing fee and the written guarantee of the loan by Mr. John P. Onopa, Mr. Adam R. Anders, and Mr. Kyle E. Ciske. If not so accepted, the City shall have no further obligation hereunder.

(Signatures continued on next page)

CITY OF WEST ALLIS

Date: _____

By: _____
Patrick Schloss
Economic Development Executive Director

The foregoing Commitment, as well as the terms and conditions referred to therein, are hereby accepted.

**West Allis Brewing Property LLC
Ope Brewing Property LLC**

Date: _____

By: _____
John P. Onopa, Owner and member

Date: _____

By: _____
Adam R. Anders, Owner and member

Date: _____

By: _____
Kyle E. Ciske, Owner and member

Received Acceptance and Loan Processing Fee:

By: _____
Shaun Mueller
Development Project Manager

Date: _____

Attachments

**CITY OF WEST ALLIS
RESOLUTION R-2022-0791**

**RESOLUTION RELATIVE TO THE AGREEMENT WITH THE VILLAGE OF
GREENDALE FOR PUBLIC HEALTH SERVICES FOR THE YEAR 2023**

WHEREAS, the City of West Allis has a fully qualified Public Health Department that is capable of providing such services to other municipalities; and

WHEREAS, the Village of Greendale has requested assistance from West Allis to provide such services; and

WHEREAS, it is in the best interest of both the City and Village to enter into an intergovernmental agreement on the provision of such services and is consistent the City of West Allis 2022-2026 Strategic Plan which includes one of the aspirations as collaboration and shared services.

NOW, THEREFORE, BE IT RESOLVED by the Common Council of the City of West Allis that the attached 2023 Agreement for Public Health Services be and is hereby approved.

SECTION 1: **ADOPTION** “R-2022- 0791” of the City Of West Allis Municipal Resolutions is hereby *added* as follows:

A D O P T I O N

R-2022-0791(*Added*)

PASSED AND ADOPTED BY THE CITY OF WEST ALLIS COUNCIL NOVEMBER
15, 2022

	AYE	NAY	ABSENT	ABSTAIN
Ald. Vince Vitale	_____	_____	_____	_____
Ald. Tracy Stefanski	_____	_____	_____	_____
Ald. Marty Weigel	_____	_____	_____	_____
Ald. Suzzette Grisham	_____	_____	_____	_____
Ald. Danna Kuehn	_____	_____	_____	_____
Ald. Thomas Lajsic	_____	_____	_____	_____
Ald. Dan Roadt	_____	_____	_____	_____
Ald. Rosalie Reinke	_____	_____	_____	_____
Ald. Kevin Haass	_____	_____	_____	_____

Attest

Presiding Officer

Rebecca Grill, City Clerk, City Of West Allis

Dan Devine, Mayor, City Of West Allis

2023 AGREEMENT FOR PUBLIC HEALTH SERVICES

This Agreement made this 1st day of January 2023, by and between the VILLAGE OF GREENDALE ("Village") and the CITY OF WEST ALLIS ("City"), both municipal corporations located in Milwaukee County, Wisconsin.

WITNESSETH:

WHEREAS, Section 66.0301(2) of the Wisconsin Statutes authorizes cities and villages to enter into inter-governmental cooperation agreements for the receipt or furnishing of services or the joint exercise of any power or duty required or authorized by law.

WHEREAS, for 2023, the Village desires to have the City provide certain environmental health services for the Village, and the City is willing to provide such services upon the terms and conditions hereinafter set forth.

NOW, THEREFORE, it is hereby agreed as follows:

SECTION 1. SCOPE OF SERVICES.

City shall provide environmental public health services to Village. The services to be provided shall consist of the following programs and activities:

- A. Environmental health services as more fully set forth in Appendix A, which is attached and made a part hereof.
- B. Provide technical expertise in assessing and evaluating code enforcement and nuisance cases.
- C. Generate and submit all required environmental health reports to state agencies.
- D. Maintain all written and electronic documents prepared by and for Greendale consistent with Wisconsin Confidentiality Statutes.
- E. Perform all requirements of an agent under contract with the Wisconsin Department of Agriculture,
- F. Trade and Consumer Protection for the licensing and inspection of restaurants, hotels, motels, bed and breakfast establishments, tourist rooming houses, vending machines, swimming pools, and all other licensed establishments contained in the agreement.
- G. Perform all requirements of an agent under contract with the Wisconsin Department of Safety and Professional Services for the licensing and inspection of tattoo and body art facilities.
- H. Perform such other and further activities as may be necessary and proper to provide the services enumerated herein.

SECTION 2. PROVISION OF SERVICES.

- A. All services shall be provided by the City of West Allis Health Department under the direction and supervision of its Health Commissioner. In providing such services, the Health Commissioner shall work under the general advisement of the Village Manager.
- B. Services will be provided only to Greendale residents and businesses. All services will be provided at the West Allis Health Department, except as otherwise specifically provided herein.
- C. Annual report on the public health services and activities provided for the Village of Greendale.

SECTION 3. COMPENSATION.

- A. The Village will pay the City a monthly fee of One Thousand Three Hundred Seventy Four dollars (\$1,374) for the services to be provided under this Agreement for 2023. The fee is due and payable on the first of each month during the term of this Agreement and any renewal thereof.
- B. The City will collect and retain of all license and inspection fees associated with Agent contract work.
- C. The Village and City will discuss annually any renegotiation of the monthly fee for the subsequent calendar years.
- D. A credit of \$824.00 will be applied by the City to one of the monthly fees paid by the Village for professional liability coverage of \$150,000. Said credit shall represent 50% of the cost of said liability coverage maintained by the Village.

SECTION 4. TERM.

- A. The term of this Agreement shall commence on January 1, 2023 and end on December 31, 2023.

- B. Each party has the right to terminate this Agreement upon written notice of termination at least six (6) months prior to the termination date contained in said notice.
- C. This Agreement will be automatically extended for successive annual periods by further mutual written agreement under such terms and conditions as may be mutually agreeable to both parties.

SECTION 5. EMPLOYMENT RELATIONSHIP.

All wage and disability payments, pensions, worker's compensation claims and medical expenses for City employees providing services under this Agreement shall be paid by City. It being understood and agreed that such employees are the employees of City and not the agents or employees of Village.

SECTION 6. LIABILITY AND INDEMNIFICATION.

Village agrees to indemnify, defend and save harmless City and its officers, directors, employees and agents from and against any and all liability for injuries or damages to persons or property as a result of this Agreement or the provision of services under this Agreement up to but not exceeding the sum of One Hundred Fifty Thousand Dollars (\$150,000) per occurrence. This indemnification applies to, but is not limited to, City's liability to Village or third parties in contract, in tort or under federal or state law arising or resulting from performance or failure to perform under this Agreement, and in addition, for any and all related expenses, including defense costs and attorneys fees, except as provided in Section 5. Village shall not indemnify nor be responsible for reimbursement of expenses regarding liability and loss exceeding One Hundred Fifty Thousand Dollars (\$150,000) per occurrence.

SECTION 7. AMENDMENTS.

Changes in this Agreement, to include any modification or addition to the services enumerated herein, shall be made only by an instrument in writing executed by the parties.

IN WITNESS WHEREOF, the parties to this Agreement have caused this instrument to be executed by their respective officers as of the day and year first above written.

CITY OF WEST ALLIS, a municipal corporation

By: _____
Dan Devine, Mayor

Attest:

Rebecca Grill, City Administrator

Countersigned by:

Jason Kaczmarek, Finance Director

In the Presence of:

VILLAGE OF GREENDALE, a municipal corporation

By: _____
Jason Cyborowski, Village President

Attest:

Kristen Victory, Village Finance Director

Countersigned by:

Mike Hawes, Village Manager

2023 AGREEMENT FOR PUBLIC HEALTH SERVICES

This Agreement made this 1st day of January 2023, by and between the VILLAGE OF GREENDALE ("Village") and the CITY OF WEST ALLIS ("City"), both municipal corporations located in Milwaukee County, Wisconsin.

WITNESSETH:

WHEREAS, Section 66.0301(2) of the Wisconsin Statutes authorizes cities and villages to enter into inter-governmental cooperation agreements for the receipt or furnishing of services or the joint exercise of any power or duty required or authorized by law.

WHEREAS, for 2023, the Village desires to have the City provide certain environmental health services for the Village, and the City is willing to provide such services upon the terms and conditions hereinafter set forth.

NOW, THEREFORE, it is hereby agreed as follows:

SECTION 1. SCOPE OF SERVICES.

City shall provide environmental public health services to Village. The services to be provided shall consist of the following programs and activities:

- A. Environmental health services as more fully set forth in Appendix A, which is attached and made a part hereof.
- B. Provide technical expertise in assessing and evaluating code enforcement and nuisance cases.
- C. Generate and submit all required environmental health reports to state agencies.
- D. Maintain all written and electronic documents prepared by and for Greendale consistent with Wisconsin Confidentiality Statutes.
- E. Perform all requirements of an agent under contract with the Wisconsin Department of Agriculture,
- F. Trade and Consumer Protection for the licensing and inspection of restaurants, hotels, motels, bed and breakfast establishments, tourist rooming houses, vending machines, swimming pools, and all other licensed establishments contained in the agreement.
- G. Perform all requirements of an agent under contract with the Wisconsin Department of Safety and Professional Services for the licensing and inspection of tattoo and body art facilities.
- H. Perform such other and further activities as may be necessary and proper to provide the services enumerated herein.

SECTION 2. PROVISION OF SERVICES.

- A. All services shall be provided by the City of West Allis Health Department under the direction and supervision of its Health Commissioner. In providing such services, the Health Commissioner shall work under the general advisement of the Village Manager.
- B. Services will be provided only to Greendale residents and businesses. All services will be provided at the West Allis Health Department, except as otherwise specifically provided herein.
- C. Annual report on the public health services and activities provided for the Village of Greendale.

SECTION 3. COMPENSATION.

- A. The Village will pay the City a monthly fee of One Thousand Three Hundred Seventy Four dollars (\$1,374) for the services to be provided under this Agreement for 2023. The fee is due and payable on the first of each month during the term of this Agreement and any renewal thereof.
- B. The City will collect and retain of all license and inspection fees associated with Agent contract work.
- C. The Village and City will discuss annually any renegotiation of the monthly fee for the subsequent calendar years.
- D. A credit of \$824.00 will be applied by the City to one of the monthly fees paid by the Village for professional liability coverage of \$150,000. Said credit shall represent 50% of the cost of said liability coverage maintained by the Village.

SECTION 4. TERM.

- A. The term of this Agreement shall commence on January 1, 2023 and end on December 31, 2023.

- B. Each party has the right to terminate this Agreement upon written notice of termination at least six (6) months prior to the termination date contained in said notice.
- C. This Agreement will be automatically extended for successive annual periods by further mutual written agreement under such terms and conditions as may be mutually agreeable to both parties.

SECTION 5. EMPLOYMENT RELATIONSHIP.

All wage and disability payments, pensions, worker's compensation claims and medical expenses for City employees providing services under this Agreement shall be paid by City. It being understood and agreed that such employees are the employees of City and not the agents or employees of Village.

SECTION 6. LIABILITY AND INDEMNIFICATION.

Village agrees to indemnify, defend and save harmless City and its officers, directors, employees and agents from and against any and all liability for injuries or damages to persons or property as a result of this Agreement or the provision of services under this Agreement up to but not exceeding the sum of One Hundred Fifty Thousand Dollars (\$150,000) per occurrence. This indemnification applies to, but is not limited to, City's liability to Village or third parties in contract, in tort or under federal or state law arising or resulting from performance or failure to perform under this Agreement, and in addition, for any and all related expenses, including defense costs and attorneys fees, except as provided in Section 5. Village shall not indemnify nor be responsible for reimbursement of expenses regarding liability and loss exceeding One Hundred Fifty Thousand Dollars (\$150,000) per occurrence.

SECTION 7. AMENDMENTS.

Changes in this Agreement, to include any modification or addition to the services enumerated herein, shall be made only by an instrument in writing executed by the parties.

IN WITNESS WHEREOF, the parties to this Agreement have caused this instrument to be executed by their respective officers as of the day and year first above written.
CITY OF WEST ALLIS, a municipal corporation

By: _____
Dan Devine, Mayor

Attest:

Rebecca Grill, City Administrator

Countersigned by:

Jason Kaczmarek, Finance Director

In the Presence of:

Melanie Van K... ..

Melanie Van K... ..

Melanie Van K... ..

VILLAGE OF GREENDALE, a municipal corporation

By: Jason Cyborowski
Jason Cyborowski, Village President

Attest: Kristen Victory
Kristen Victory, Village Finance Director

Countersigned by: Mike Hawes
Mike Hawes, Village Manager

**CITY OF WEST ALLIS
RESOLUTION R-2022-0796**

**RESOLUTION TO APPROVE BID OF MUSSON BROS., INC. FOR SANITARY
SEWER CONNECTION LINERS IN VARIOUS LOCATIONS IN THE CITY OF
WEST ALLIS IN THE AMOUNT OF \$299,950**

WHEREAS, The Board of Public Works reports that it duly advertised for bids for the furnishing of certain materials and the performance of all work required for the improvements in a certain area as hereinafter described; that the bids received as shown on the attached bid report were reasonable and hereby recommends and deems it to be for the best interests of the City of West Allis that the bid of Musson Bros ., Inc. for 2022 Project No. 18 be accepted.

NOW THEREFORE, BE IT RESOLVED By the Common Council of the City of West Allis that the bid of Musson Bros., Inc. for 2022 Project No. 18 for the installation of connection liners in the sanitary sewer system at:

Various Locations within the City of West Allis

(PLAN FILE NOS. X-931)

for the sum of Two Hundred Ninety-Nine Thousand, Nine Hundred Fifty and no/100 dollars (\$299,950) be accepted, and the proper City officers are hereby authorized and directed to enter into contractual relations with said contractor for the performance of said work, in accordance with the prices submitted in their proposal and with the specifications of the City of West Allis, and that all other bids received for same be rejected; and,

BE IT FURTHER RESOLVED That said improvements be installed with funding by Sanitary Sewer Funds.

SECTION 1: **ADOPTION** “R-2022-0796” of the City Of West Allis
Municipal Resolutions is hereby *added* as follows:

ADOPTION

R-2022-0796(*Added*)

PASSED AND ADOPTED BY THE CITY OF WEST ALLIS COUNCIL

_____.

	AYE	NAY	ABSENT	ABSTAIN
Ald. Vince Vitale	_____	_____	_____	_____
Ald. Tracy Stefanski	_____	_____	_____	_____
Ald. Marty Weigel	_____	_____	_____	_____
Ald. Suzzette Grisham	_____	_____	_____	_____
Ald. Danna Kuehn	_____	_____	_____	_____
Ald. Thomas Lajsic	_____	_____	_____	_____
Ald. Dan Roadt	_____	_____	_____	_____
Ald. Rosalie Reinke	_____	_____	_____	_____
Ald. Kevin Haass	_____	_____	_____	_____

Attest

Presiding Officer

Rebecca Grill, City Clerk, City Of
West Allis

Dan Devine, Mayor, City Of West
Allis

**CITY OF WEST ALLIS
RESOLUTION R-2022-0797**

**RESOLUTION TO APPROVE BID OF VISU-SEWER FOR SANITARY AND
STORM SEWER LINING, SPOT LINING AND GROUTING IN VARIOUS
LOCATIONS IN THE CITY OF WEST ALLIS IN THE AMOUNT OF \$240,747.50**

WHEREAS, The Board of Public Works reports that it duly advertised for bids for the furnishing of certain materials and the performance of all work required for the improvements in a certain area as hereinafter described; that the bids received as shown on the attached bid report were reasonable and hereby recommends and deems it to be for the best interests of the City of West Allis that the bid of Visu -Sewer for 2022 Project No. 17 be accepted.

NOW THEREFORE, BE IT RESOLVED By the Common Council of the City of West Allis that the bid of Visu-Sewer for 2022 Project No. 17 sanitary sewer and storm sewer lining, sanitary sewer and storm sewer spot lining, sanitary sewer grouting and sanitary manhole grouting in:

Various Locations within the City of West Allis

(PLAN FILE NOS. X-930)

for the sum of Two Hundred Forty Thousand, Seven Hundred Forty-Seven and 50/100 dollars (\$240,747.50) be accepted, and the proper City officers are hereby authorized and directed to enter into contractual relations with said contractor for the performance of said work, in accordance with the prices submitted in their proposal and with the specifications of the City of West Allis, and that all other bids received for same be rejected; and,

BE IT FURTHER RESOLVED That said improvements be installed with funding by Sanitary Sewer Funds and Storm Water Management Funds.

SECTION 1: **ADOPTION** “R-2022-0797” of the City Of West Allis Municipal Resolutions is hereby *added* as follows:

A D O P T I O N

R-2022-0797(*Added*)

PASSED AND ADOPTED BY THE CITY OF WEST ALLIS COUNCIL

_____.

	AYE	NAY	ABSENT	ABSTAIN
Ald. Vince Vitale	_____	_____	_____	_____
Ald. Tracy Stefanski	_____	_____	_____	_____
Ald. Marty Weigel	_____	_____	_____	_____
Ald. Suzzette Grisham	_____	_____	_____	_____
Ald. Danna Kuehn	_____	_____	_____	_____
Ald. Thomas Lajsic	_____	_____	_____	_____
Ald. Dan Roadt	_____	_____	_____	_____
Ald. Rosalie Reinke	_____	_____	_____	_____
Ald. Kevin Haass	_____	_____	_____	_____

Attest

Presiding Officer

Rebecca Grill, City Clerk, City Of
West Allis

Dan Devine, Mayor, City Of West
Allis

**CITY OF WEST ALLIS
RESOLUTION R-2022-0798**

**RESOLUTION AUTHORIZING 10-YEAR CONTRACT FOR AXON OFFICER
SAFETY PLAN**

WHEREAS, the West Allis Police Department has been using various Axon products for approximately 15 years and currently uses Axon Tasers, Axon Body Worn Cameras, Axon Interview Room, Axon Evidence.com, and Axon Unlimited Storage; and,

WHEREAS, the West Allis Police Department has found these Axon products to be durable, reliable, and easy to use; that Axon's customer support has also been found to be dependable, reliable, and efficient in resolving issues; and,

WHEREAS, the West Allis Police Department uses a variety of other systems and tools, many of which are aging and need replacing, have limitations (e.g., issues with storage capacity, involve manual processes, require more maintenance and troubleshooting by staff), and prevent the West Allis Police Department from being as efficient as it could be; and,

WHEREAS, Axon offers a variety of solutions that would adequately replace these systems and tools; that acquiring these Axon solutions would allow the West Allis Police Department to replace older solutions, invest in long term state-of-the-art technology rather than repair older technology, obtain excellent evidence for criminal prosecutions, provide transparency with the community, reduce quantity and/or level of force in use-of-force incidents, and better manage liability and reduce frivolous claims; and

WHEREAS, Axon offers a variety of additional solutions; that acquiring these Axon solutions would allow the West Allis Police Department to provide excellent training to staff, allow staff to be more efficient, obtain excellent evidence for criminal prosecutions to a greater extent, provide transparency with the community to a greater extent, help reduce quantity and/or level of force in use-of-force incidents to a greater extent, better manage liability and reduce frivolous claims to a greater extent; and strengthen the reputation of the West Allis Police Department for being a highly professional law enforcement agency; and,

WHEREAS, the Axon Officer Safety Plan includes all of these solutions that would be beneficial to the West Allis Police Department; that the West Allis Police Department believes the Axon Officer Safety Plan will provide important and progressive technology including: Auto-Tagging, Auto Transcribe, Body Worn 3 Cameras, Citizen for Communities, Citizen One-to-One, Fleet 3 Squad Cameras, Interview Room Cameras, Performance, Redaction Assistant, Respond, Signal Technology, Taser 7 Electronic Control Devices, Third Party Video Playback, Unlimited Storage, Standards, and Virtual Reality Training; and

WHEREAS, committing to a 10-year contract for the Axon Officer Safety Plan would save a substantial amount of manpower for the West Allis Police Department and the West Allis IT Department, as the need to maintain and/or replace current systems and tools would be eliminated and Axon would provide the great majority of support for hardware and software; and,

WHEREAS, a 10-year contract for the Axon Officer Safety Plan would include hardware, software, accessories, training programs, training supplies, 24/7 customer support, equipment refreshes, and product warranties that cover maintenance, and repairs; that pricing would be locked for the duration of the 10-year contract; and

WHEREAS, the West Allis Police Department believes a commitment to the Axon Officer Safety Plan for 10 years will be beneficial to the West Allis Police Department and is in-line with the City of West Allis Strategic Plan; that the commitment will contribute to having a healthy and attractive police department and community; that it will strengthen partnerships in the community; that it will help in managing liability which demonstrates fiscal responsibility; that it will create and maintain a long-term solution for many police department needs; that it will demonstrate excellence in the City of West Allis and the West Allis Police Department; and,

WHEREAS, the West Allis Police Department has received a quote from Axon; and,

WHEREAS, the West Allis Police Department has consulted with the West Allis Finance Department to help ensure best possible pricing and that pricing is consistent with existing competitive contracts (e.g., NASPO ValuePoint competitive contract); and,

WHEREAS, the West Allis Police Department and West Allis Finance Department have researched the vendor pricing and offering of no more than \$399,334 per year for the necessary software, hardware, licensing, and cloud-based storage, to be fair and reasonable; and,

WHEREAS, the adopted 2023 City of West Allis Annual Budget includes funding for this commitment;

NOW THEREFORE, BE IT RESOLVED by the Common Council of the City of West Allis that the West Allis Police Department is authorized to enter into a 10-year professional services agreement with Axon for a total sum not to exceed \$399,334,00 per year.

SECTION 1: **ADOPTION** “R-2022-0798” of the City Of West Allis Municipal Resolutions is hereby *added* as follows:

ADOPTION

R-2022-0798(*Added*)

PASSED AND ADOPTED BY THE CITY OF WEST ALLIS COUNCIL

_____.

	AYE	NAY	ABSENT	ABSTAIN
Ald. Vince Vitale	_____	_____	_____	_____
Ald. Tracy Stefanski	_____	_____	_____	_____
Ald. Marty Weigel	_____	_____	_____	_____
Ald. Suzzette Grisham	_____	_____	_____	_____
Ald. Danna Kuehn	_____	_____	_____	_____
Ald. Thomas Lajsic	_____	_____	_____	_____
Ald. Dan Roadt	_____	_____	_____	_____
Ald. Rosalie Reinke	_____	_____	_____	_____
Ald. Kevin Haass	_____	_____	_____	_____

Attest

Presiding Officer

Rebecca Grill, City Clerk, City Of
West Allis

Dan Devine, Mayor, City Of West
Allis



CLAIMANT CONTACT INFORMATION

Name: Alarcon Diaz Zacarias Phone: (414) 491-0649
Address: 1647 S Casar Echavez Dr Email: _____
Milwaukee WI 53204

INSTRUCTIONS

Complete this form, print and sign it, and serve a hard copy upon the West Allis City Clerk. If you have questions about how to fill out this form, please contact a private attorney who can assist you.

NOTICE OF CLAIM

Date of incident: 8/17/2022 Time of day: 3 am
Location: West Allis - I-94 East

Describe the circumstances of your claim here. You may attach additional sheets or exhibits. Some helpful information may be the police report, pictures of the incident or damage, a diagram of the location, a list of injuries, a list of property damage, names and contact information for witnesses to the incident, and any other information relevant to the circumstances.

they pop my tires; the cost of repair.
\$578.54 Was a police chase they thought
was my truck the officer pop my front
two tires

Check one:

- I am seeking damages at this time (complete Claim Amount section below)
- I am submitting this notice without a claim for damages. This claim is not complete and will not be processed until I submit a claim for damages on a later date.

Signed: Zacarias Alarcon Diaz Date: 10 31 - 22

CLAIM AMOUNT

To complete this claim, attach an itemized statement of damages sought. If any damages are for repair to property, include at least 2 estimates for repairs.

The total amount sought is: \$ 837 54

SAVE

PRINT





Assessment Reduction Services, LLC

Email: stevetraudt@tax-appeal.com

Phone: WI 414-737-3325 CO 303-923-8030

P.O. Box 395 Pewaukee, WI 53072

November 3, 2022

Ms. Rebecca Grill, City Clerk
Ms. Gina Gresch, Deputy City Clerk
City of West Allis
7525 West Greenfield Avenue, Room 108
West Allis, Wisconsin 53214

**RE: Roman Electric Co.
Personal Property Claim under 74.35
ACCT 30372 222 S 114th Street**

Served in person

Dear Ms. Grill and Gresch:

We hereby file a claim under Wisconsin Statutes 74.35 [Recovery of unlawful taxes] for a portion of the personal property taxes assessed to this taxpayer for the 2022 tax year. The claim is based upon 74.33(1)(c) or (e) which states: ***The property is exempt by law from taxation, except as provided under sub. (2) or A double assessment has been made.***

The claim relates to property that is exempt under several statutory provisions including:

- 70.111(27), which states:

(27) MACHINERY, TOOLS, AND PATTERNS.

(a) In this subsection, "machinery" means a structure or assemblage of parts that transmits force, motion, or energy from one part to another in a predetermined way by electrical, mechanical, or chemical means. "Machinery" does not include a building.

(b) Beginning with the property tax assessments as of January 1, 2018, machinery, tools, and patterns, not including such items used in manufacturing.

- 70.11(39), which states:
(39) Computers. Mainframe computers, minicomputers, personal computers, networked personal computers, servers, terminals, monitors, disk drives, electronic peripheral equipment, tape drives, printers, basic operational programs, systems software, and prewritten software. The exemption under this subsection does not apply to custom software, fax machines, copiers, equipment with embedded computerized components or telephone systems,

including equipment that is used to provide telecommunications services, as defined in s. 76.80 (3). For the purposes of s. 79.095, the exemption under this subsection does not apply to property that is otherwise exempt under this chapter.

Roman Electric Co. filed their 2022 personal property tax return (PA-003) showing a reported taxable value of \$1,914,725. Based upon the adjustments agreed to by the City of West Allis included in Exhibit 1, the revised taxable value would be \$463,975. The tax rate for 2022 has not yet been determined and no tax bill has yet been issued. We ask that the City approve the claim and rescind the personal property tax on the property assessed in error accordingly.

Sincerely,

ASSESSMENT REDUCTION SERVICES, LLC



Steve Traudt

enclosure – property tax adjustment calculation

cc: Mr. Kail J. Decker, City of West Allis

Asset	ORIGINAL Schedule	Cost	Index	Original VALUE	REVISED Schedule	Revised VALUE
Material carts	D	\$ 38,709	0.925	35,806	D	35,806
Sonicwall Appliance	D	\$ 7,900	0.925	7,307	D	7,307
Office Furniture	D	\$ 417,154	0.925	385,868	D	385,868
Generator	D	\$ 15,721	0.925	14,542	C	-
Warehouse Racking	D	\$ 24,512	0.925	22,674	D	22,674
Schedule D				466,197		451,654
Low Voltage - Data /						
Internal labor	H	\$ 40,841	0.625	25,526	D-1	0
Poblocki Paving	H	\$ 167,307	0.625	104,567	R/P	0
Century Fence	H	\$ 32,489	0.625	20,306	R/P	0
Landscaping	H	\$ 56,770	0.625	35,481	R/P	0
remove skylight / roof repair/ painting	H	\$ 15,095	0.625	9,434	R/P	0
replaced drywall with frosted glass wall	H	\$ 270,849	0.625	169,281	R/P	0
Additional data -						
internal labor	H	\$ 288,822	0.625	180,514	D-1	0
Internal labor -						
electrical	H	\$ 522,818	0.625	326,761	R/P	0
Lighting	H	\$ 77,263	0.625	48,289	R/P	0
Trenching outdoor lighting	H	\$ 11,485	0.625	7,178	R/P	0
Fire Alarm	H	\$ 4,700	0.625	2,938	R/P	0
Rekey locks & automatic entrances	H	\$ 480	0.625	300	R/P	0
HVAC	H	\$ 159,271	0.625	99,545	R/P	0
Ceilings	H	\$ 335,510	0.625	209,694	R/P	0
Plumbing	H	\$ 262,278	0.625	163,924	R/P	0
Generator related						
set-up	H	\$ 3,290	0.625	2,056	C	0
Frosting on tech walls	H	\$ 30,370	0.625	18,981	R/P	0
Tax on above items	H	\$ 12,675	0.625	7,922	R/P	0
Kitchen equipment						
(microwaves / stove)	H	\$ 4,769	0.625	2,981	C	0
move HP Printer to new HQ	H	\$ 850	0.625	531	D-1	0
Signage	H	\$ 12,533	0.625	7,833	H	7,833
Sound System	H	\$ 533	0.625	333	H	333
Awning	H	\$ 1,846	0.625	1,154	H	1,154

EXHIBIT 1

Schedule H	1,445,528	9,320
Supplies	3000	3000
Reported value	1,914,725	463,975



CLAIMANT CONTACT INFORMATION

Name: Elizabeth Ritchey Phone: 414-801-5202
Address: 10316 S. 88th St Email: SKysmama.er@gmail.com
West Allis, WI 53214

INSTRUCTIONS

Complete this form, print and sign it, and serve a hard copy upon the West Allis City Clerk. If you have questions about how to fill out this form, please contact a private attorney who can assist you.

NOTICE OF CLAIM

Date of incident: 10-31-22 Time of day: AM
Location: 10316 S. 88th St. West Allis 53214

Describe the circumstances of your claim here. You may attach additional sheets or exhibits. Some helpful information may be the police report, pictures of the incident or damage, a diagram of the location, a list of injuries, a list of property damage, names and contact information for witnesses to the incident, and any other information relevant to the circumstances.

My car was parked on the street for the night. Sometime in the morning the city came to pick up a pile of leaves that were behind my car. In the process my car was hit. Someone from the city named Joe called me after the fact and told me what happened. He gave me the number 414-302-8800 for contact and he called the police

Check one:

- I am seeking damages at this time (complete Claim Amount section below)
- I am submitting this notice without a claim for damages. This claim is not complete and will not be processed until I submit a claim for damages on a later date.

Signed: Elizabeth Ritchey Date: 11-8-22

CLAIM AMOUNT

To complete this claim, attach an itemized statement of damages sought. If any damages are for repair to property, include at least 2 estimates for repairs.

The total amount sought is: \$ 3534.27

SAVE

PRINT



CLAIMANT CONTACT INFORMATION

Name: JILL & STACY LEHRER Phone: 414-552-8539
Address: 832 S. 94 ST. Email: NEWCHAPTER016@GMAIL.COM
WEST ALLIS, WI 53214 STACY LEHRER@GMAIL.COM

INSTRUCTIONS

Complete this form, print and sign it, and serve a hard copy upon the West Allis City Clerk. If you have questions about how to fill out this form, please contact a private attorney who can assist you.

NOTICE OF CLAIM

Date of incident: 11-5-2022 Time of day: 5:00 PM
Location: 832 S. 94th St. WEST ALLIS, WI

Describe the circumstances of your claim here. You may attach additional sheets or exhibits. Some helpful information may be the police report, pictures of the incident or damage, a diagram of the location, a list of injuries, a list of property damage, names and contact information for witnesses to the incident, and any other information relevant to the circumstances.

A CITY TREE LOCATED IN FRONT OF 833 S. 94 ST. CAME DOWN ON OUR VEHICLE PARKED IN FRONT OF 832 S. 94th ST. OWNERS OF 833 S. 94 ST REPORTED TO US THAT THEY REPORTED THE TREE LOOK TO BE ROTTING AND SPLITTING ON TWO OCCASIONS AND CITY DID NOT TAKE TREE DOWN. WEST ALLIS POLICE OFFICER SEGHERS RESPONDED AND COMPLETED A PROPERTY DAMAGE REPORT #22-0-41797.
PICTURES AND ESTIMATE EMAILED TO CLERKS @ WESTALLIS.GOV

TURN
→

Check one:

- I am seeking damages at this time (complete Claim Amount section below)
- I am submitting this notice without a claim for damages. This claim is not complete and will not be processed until I submit a claim for damages on a later date.

Signed: [Signature] Date: 11/11/2022

CLAIM AMOUNT

To complete this claim, attach an itemized statement of damages sought. If any damages are for repair to property, include at least 2 estimates for repairs.

The total amount sought is: \$ 18,000

SAVE

PRINT

WITNESSES:

OWNERS of 833 S. 94

JENNIFER YOGURTIAN

MICHAEL SEVERSON

PH # 414-732-4575

PH # 262-573-2268

8008 2 11

11/11/08

Handwritten notes, possibly a list or checklist, mostly illegible due to blurring and fading.

X

Monthly Listing of Claims Paid
October 2022

Payment Date: 10/03/2022

Check#	Vendor	GL Account	Proj No	Description	Amount
30800	A. GALENA, LLC	223-7602-563.43-03		HAPRENT-10-22	1,192.00
30800 - Summary					1,192.00
30801	ADSIT, CHRIS	223-7602-563.43-03		HAPRENT-10-22	934.00
30801 - Summary					934.00
30802	AMBROSELLI, DOMINIC	223-7602-563.43-03		HAPRENT-10-22	882.00
30802 - Summary					882.00
30803	AMU-PLUS, LLC	223-7602-563.43-03		HAPRENT-10-22	463.00
30803 - Summary					463.00
30804	ANDERSON, JEFFREY	223-7602-563.43-03		HAPRENT-10-22	892.00
30804 - Summary					892.00
30805	ANDERSON, JEFFREY	223-7602-563.43-03		HAPRENT-10-22	1,834.00
30805 - Summary					1,834.00
30806	APPLETON RENTAL HOMES LLC	223-7602-563.43-03		HAPRENT-10-22	408.00
30806 - Summary					408.00
30807	ASPENWOOD GLEN	226-7605-563.43-08		HAPRENT-10-22	544.00
30807 - Summary					544.00
30808	ATD RENTALS 80 LLC	223-7602-563.43-03		HAPRENT-10-22	585.00
30808 - Summary					585.00
30809	ATID PROPERTIES	223-7602-563.43-03		HAPRENT-10-22	489.00
30809 - Summary					489.00
30810	AUTUMN GLEN LLC	223-7602-563.43-03		HAPRENT-10-22	897.00
30810 - Summary					897.00
30811	AVILA, JORGE	223-7602-563.43-03		HAPRENT-10-22	815.00
30811 - Summary					815.00
30812	BAJIC, LUISEC/O BIECK MANAGEMENT	226-7605-563.43-08		HAPRENT-10-22	461.00
30812 - Summary					461.00
30813	BAKER, BRADLEY	223-7602-563.43-03		HAPRENT-10-22	1,200.00
30813 - Summary					1,200.00
30814	BAM RENTALS, LLC	223-7602-563.43-03		HAPRENT-10-22	514.00
30814 - Summary					514.00
30815	BARTSCH MANAGEMENT, LLC	223-7602-563.43-03		HAPRENT-10-22	1,475.00
30815 - Summary					1,475.00
30816	BAYER, WERNER	223-7602-563.43-03		HAPRENT-10-22	1,807.00
30816 - Summary					1,807.00
30817	BECHER APARTMENTS, INC	223-7602-563.43-03		HAPRENT-10-22	1,552.00
30817 - Summary					1,552.00
30818	BECHER PROPERTY LLC	223-7602-563.43-03		HAPRENT-10-22	775.00
30818 - Summary					775.00
30819	BELOIT ROAD SENIOR APARTMENTS LLC	223-7602-563.43-07		HAPRENT-10-22	40,894.00
30819 - Summary					40,894.00
30820	BERKSHIRE HATHAWAY HOMESERVICES	223-7602-563.43-03		HAPRENT-10-22	374.00
30820 - Summary					374.00
30821	BERRADA PROPERTIES MGT INC	226-7605-563.43-08		HAPRENT-10-22	671.00
30821 - Summary					671.00
30822	BIECK MANAGEMENT, INC.	223-7602-563.43-03		HAPRENT-10-22	567.00
30822 - Summary					567.00
30823	BILL HOAG PROPERTIES, LLC	223-7602-563.43-03		HAPRENT-10-22	551.00
30823 - Summary					551.00
30824	BLAKE-WEISE MGT DBA FRENCH QUARTER	223-7602-563.43-03		HAPRENT-10-22	600.00
	BLAKE-WEISE MGT DBA FRENCH QUARTER	226-7605-563.43-08		HAPRENT-10-22	1,103.00
30824 - Summary					1,703.00
30825	BRAMBILA, EXSIQUIA RUBIO	226-7605-563.43-08		HAPRENT-10-22	845.00
30825 - Summary					845.00
30826	BRELL INVESTMENTS	226-7605-563.43-08		HAPRENT-10-22	387.00
30826 - Summary					387.00

**Monthly Listing of Claims Paid
October 2022**

Check#	Vendor	GL Account	Proj No	Description	Amount
30827	BRUCKNER, DAN	223-7602-563.43-03		HAPRENT-10-22	437.00
30827 - Summary					437.00
30828	BUCKHORN STATION HARMONY HSG, LLC	226-7605-563.43-08		HAPRENT-10-22	292.00
30828 - Summary					292.00
30829	BURNHAM HILL APTS	226-7605-563.43-08		HAPRENT-10-22	4,767.00
30829 - Summary					4,767.00
30830	BUSKA, CHARLOTTE	226-7605-563.43-08		HAPRENT-10-22	527.00
30830 - Summary					527.00
30831	BUTTITTA, NICK	223-7602-563.43-03		HAPRENT-10-22	564.00
30831 - Summary					564.00
30832	CARNEGIE PLACE	223-7602-563.43-03		HAPRENT-10-22	1,411.00
	CARNEGIE PLACE	226-7605-563.43-08		HAPRENT-10-22	1,405.00
30832 - Summary					2,816.00
30833	CARRAN, CARL	223-7602-563.43-03		HAPRENT-10-22	1,543.00
	CARRAN, CARL	226-7605-563.43-08		HAPRENT-10-22	825.00
30833 - Summary					2,368.00
30834	CITY OF WEST ALLIS-FSS DEPOSITS	223-7602-563.43-09		FSSRENT-10-22	820.00
30834 - Summary					820.00
30835	CITYWIDE RENTALS &PROPERTY MGMT LLC	223-7602-563.43-03		HAPRENT-10-22	2,130.00
30835 - Summary					2,130.00
30836	CLARKE SQUARE TERRACE HOUSING LLC	226-7605-563.43-08		HAPRENT-10-22	506.00
30836 - Summary					506.00
30837	COBALT SUPREME - CP, LLC	223-7602-563.43-03		HAPRENT-10-22	184.00
30837 - Summary					184.00
30838	COBALT SUPREME-CP, LLC	223-7602-563.43-03		HAPRENT-10-22	524.00
30838 - Summary					524.00
30839	COLON, JORGE	223-7602-563.43-03		HAPRENT-10-22	492.00
30839 - Summary					492.00
30840	CORNERSTONE MANAGEMENT ASSOC	226-7605-563.43-08		HAPRENT-10-22	1,490.00
30840 - Summary					1,490.00
30841	COTTRELL, JEFF	223-7602-563.43-03		HAPRENT-10-22	555.00
30841 - Summary					555.00
30842	CREAM CITY CAPITAL LLC	226-7605-563.43-08		HAPRENT-10-22	700.00
30842 - Summary					700.00
30843	DAYFORTH APARTMENTS LLP	226-7605-563.43-08		HAPRENT-10-22	725.00
30843 - Summary					725.00
30844	EBERLE, JOSEPH	223-7602-563.43-03		HAPRENT-10-22	834.00
30844 - Summary					834.00
30845	EDWARDS REAL ESTATE LLC	226-7605-563.43-08		HAPRENT-10-22	189.00
30845 - Summary					189.00
30846	ELITE PROPERTIES INC	223-7602-563.43-03		HAPRENT-10-22	441.00
	ELITE PROPERTIES INC	226-7605-563.43-08		HAPRENT-10-22	685.00
30846 - Summary					1,126.00
30847	ENHANCED PROPERTIES LLC	223-7602-563.43-03		HAPRENT-10-22	636.00
30847 - Summary					636.00
30848	ENIGMA PROPERTIES - 8420	226-7605-563.43-08		HAPRENT-10-22	670.00
30848 - Summary					670.00
30849	FABISZAK, MEL	223-7602-563.43-03		HAPRENT-10-22	630.00
30849 - Summary					630.00
30850	FILIATRAULT, MARK	223-7602-563.43-03		HAPRENT-10-22	525.00
30850 - Summary					525.00
30851	FLESSAS, JOHN	223-7602-563.43-03		HAPRENT-10-22	650.00
30851 - Summary					650.00
30852	FRONT GATE PROPERTIES, LLC	223-7602-563.43-03		HAPRENT-10-22	847.00
30852 - Summary					847.00
30853	GALOVIC, STEFAN	223-7602-563.43-03		HAPRENT-10-22	552.00
30853 - Summary					552.00

Monthly Listing of Claims Paid
October 2022

Check#	Vendor	GL Account	Proj No	Description	Amount
30854	GRAD, FRANK	223-7602-563.43-03		HAPRENT-10-22	1,135.00
30854 - Summary					1,135.00
30855	GRANDLICH, DANIEL	223-7602-563.43-03		HAPRENT-10-22	381.00
30855 - Summary					381.00
30856	GREENFIELD GARDEN, LLC	223-7602-563.43-03		HAPRENT-10-22	1,250.00
30856 - Summary					1,250.00
30857	GREENFIELD SENIOR APARTMENTS, LLC	226-7605-563.43-08		HAPRENT-10-22	992.00
30857 - Summary					992.00
30858	HAYMARKET LOFTS LP	226-7605-563.43-08		HAPRENT-10-22	1,009.00
30858 - Summary					1,009.00
30859	HEARTLAND-WEST ALLIS COURTYARD LLC	223-7602-563.43-03		HAPRENT-10-22	4,068.00
30859 - Summary					4,068.00
30860	HENDRICKSON, BARBARA	226-7605-563.43-08		HAPRENT-10-22	1,712.00
30860 - Summary					1,712.00
30861	HERITAGE WEST ALLIS	223-7602-563.43-03		HAPRENT-10-22	4,853.00
30861 - Summary					4,853.00
30862	HERTEL, MR STACY	223-7602-563.43-03		HAPRENT-10-22	259.00
30862 - Summary					259.00
30863	HISTORIC LOFTS ON KILBOURN	226-7605-563.43-08		HAPRENT-10-22	372.00
30863 - Summary					372.00
30864	HOCHSCHILD, LAWRENCE	223-7602-563.43-03		HAPRENT-10-22	1,077.00
	HOCHSCHILD, LAWRENCE	226-7605-563.43-08		HAPRENT-10-22	523.00
30864 - Summary					1,600.00
30865	HOFMAN, EDWARD	223-7602-563.43-03		HAPRENT-10-22	750.00
30865 - Summary					750.00
30866	HOOKER, SUSAN	223-7602-563.43-03		HAPRENT-10-22	1,433.00
30866 - Summary					1,433.00
30867	HOSPEL, BRIAN	226-7605-563.43-08		HAPRENT-10-22	246.00
30867 - Summary					246.00
30868	HOUSE, ASHLEY	223-7602-563.43-03		HAPRENT-10-22	362.00
30868 - Summary					362.00
30869	HUBINGER, ROBERT	223-7602-563.43-03		HAPRENT-10-22	974.00
30869 - Summary					974.00
30870	IMMEKUS, MICHAEL	223-7602-563.43-03		HAPRENT-10-22	775.00
30870 - Summary					775.00
30871	IRIZARRY, JOSEPH	223-7602-563.43-03		HAPRENT-10-22	404.00
30871 - Summary					404.00
30872	JJKRAHN INVESTMENTS, LLC	223-7602-563.43-03		HAPRENT-10-22	986.00
30872 - Summary					986.00
30873	JOHN ELLIOTT REALTY	223-7602-563.43-03		HAPRENT-10-22	549.00
30873 - Summary					549.00
30874	JTS PROPERTIES, LLC	223-7602-563.43-03		HAPRENT-10-22	335.00
30874 - Summary					335.00
30875	K.B. CO INVESTMENTS	226-7605-563.43-08		HAPRENT-10-22	1,418.00
30875 - Summary					1,418.00
30876	KEOUGH, MATTHEW	223-7602-563.43-03		HAPRENT-10-22	177.00
30876 - Summary					177.00
30877	KEY WAY RENTALS, LLC	223-7602-563.43-03		HAPRENT-10-22	1,707.00
30877 - Summary					1,707.00
30878	KIEFER RATH, JANE	226-7605-563.43-08		HAPRENT-10-22	516.00
30878 - Summary					516.00
30879	KLOSE JR, JOHN P.	223-7602-563.43-03		HAPRENT-10-22	1,000.00
30879 - Summary					1,000.00
30880	KNITTING FACTORY HARMONY HOUSING LL	226-7605-563.43-08		HAPRENT-10-22	1,665.00
30880 - Summary					1,665.00
30881	KORONKA, HELEN	223-7602-563.43-03		HAPRENT-10-22	504.00

Monthly Listing of Claims Paid
October 2022

Check#	Vendor	GL Account	Proj No	Description	Amount
30881 - Summary					504.00
30882	KRUEGER, RONALD	223-7602-563.43-03		HAPRENT-10-22	379.00
30882 - Summary					379.00
30883	KTI, LLC	223-7602-563.43-03		HAPRENT-10-22	725.00
30883 - Summary					725.00
30884	LADEWIG, GAVIN	223-7602-563.43-03		HAPRENT-10-22	711.00
30884 - Summary					711.00
30885	LAKE, CHRIS	223-7602-563.43-03		HAPRENT-10-22	636.00
30885 - Summary					636.00
30886	LINCOLN CREST APARTMENTS	223-7602-563.43-03		HAPRENT-10-22	9,636.00
	LINCOLN CREST APARTMENTS	226-7605-563.43-08		HAPRENT-10-22	689.00
30886 - Summary					10,325.00
30887	LOGIC PROPERTIES, LLC	223-7602-563.43-03		HAPRENT-10-22	567.00
30887 - Summary					567.00
30888	LUTZ LAND MANAGEMENT	223-7602-563.43-03		HAPRENT-10-22	630.00
30888 - Summary					630.00
30889	MAHNKE, JACK	223-7602-563.43-03		HAPRENT-10-22	1,103.00
30889 - Summary					1,103.00
30890	MAIER, NATE	223-7602-563.43-03		HAPRENT-10-22	590.00
30890 - Summary					590.00
30891	METRO RENTAL MGMT	226-7605-563.43-08		HAPRENT-10-22	365.00
30891 - Summary					365.00
30892	METROPOLITAN ASSOCIATES	223-7602-563.43-03		HAPRENT-10-22	24,903.00
	METROPOLITAN ASSOCIATES	226-7605-563.43-08		HAPRENT-10-22	1,933.00
30892 - Summary					26,836.00
30893	MIAO, XIANGDONG	223-7602-563.43-03		HAPRENT-10-22	1,107.00
30893 - Summary					1,107.00
30894	MILWAUKEE INVESTMENTS II, LLC	223-7602-563.43-03		HAPRENT-10-22	1,344.00
30894 - Summary					1,344.00
30895	MORRISON, TOM	223-7602-563.43-03		HAPRENT-10-22	1,413.00
	MORRISON, TOM	226-7605-563.43-08		HAPRENT-10-22	829.00
30895 - Summary					2,242.00
30896	MY PLACE RENTALS, LLC	223-7602-563.43-03		HAPRENT-10-22	540.00
30896 - Summary					540.00
30897	NASH, BRYAN	223-7602-563.43-03		HAPRENT-10-22	399.00
30897 - Summary					399.00
30898	NATIONAL AVE LOFTS LLC	226-7605-563.43-08		HAPRENT-10-22	424.00
30898 - Summary					424.00
30899	NAWROCKI, GREGORY	226-7605-563.43-08		HAPRENT-10-22	802.00
30899 - Summary					802.00
30900	NYMAN, MICHAEL	223-7602-563.43-03		HAPRENT-10-22	309.00
30900 - Summary					309.00
30901	O'CONNELL, KAYE	223-7602-563.43-03		HAPRENT-10-22	632.00
30901 - Summary					632.00
30902	OCTANE CAPITAL PARTNERS, LLC	226-7605-563.43-08		HAPRENT-10-22	514.00
30902 - Summary					514.00
30903	OLSZEWSKI, PATRICE	223-7602-563.43-03		HAPRENT-10-22	631.00
30903 - Summary					631.00
30904	ORTH, JOSEPH OR LONI	223-7602-563.43-03		HAPRENT-10-22	550.00
30904 - Summary					550.00
30905	OTT, DONALD	223-7602-563.43-03		HAPRENT-10-22	605.00
30905 - Summary					605.00
30906	PATTEE, RYAN	223-7602-563.43-03		HAPRENT-10-22	874.00
30906 - Summary					874.00
30907	PECSI, PAUL	223-7602-563.43-03		HAPRENT-10-22	983.00
	PECSI, PAUL	226-7605-563.43-08		HAPRENT-10-22	1,218.00
30907 - Summary					2,201.00

Monthly Listing of Claims Paid
October 2022

Check#	Vendor	GL Account	Proj No	Description	Amount
30908	PERFORMANCE ASSET MANAGEMENT	226-7605-563.43-08		HAPRENT-10-22	721.00
30908 - Summary					721.00
30909	PETERS, ROBERT & NANCY	226-7605-563.43-08		HAPRENT-10-22	599.00
30909 - Summary					599.00
30910	PICKART, ,KAY	223-7602-563.43-03		HAPRENT-10-22	1,031.00
30910 - Summary					1,031.00
30911	PLENNES, TIMOTHY	223-7602-563.43-03		HAPRENT-10-22	825.00
30911 - Summary					825.00
30912	PORCH LIGHT PROPERTY MGMT	223-7602-563.43-03		HAPRENT-10-22	919.00
	PORCH LIGHT PROPERTY MGMT	226-7605-563.43-08		HAPRENT-10-22	496.00
30912 - Summary					1,415.00
30913	REIS PROPERTY MANAGEMENT	223-7602-563.43-03		HAPRENT-10-22	694.00
30913 - Summary					694.00
30914	RENT ME WISCONSIN	223-7602-563.43-03		HAPRENT-10-22	448.00
30914 - Summary					448.00
30915	REVIVING HOMES, LLC	223-7602-563.43-03		HAPRENT-10-22	786.00
30915 - Summary					786.00
30916	RICH FIELD PROPERTY	223-7602-563.43-03		HAPRENT-10-22	794.00
30916 - Summary					794.00
30917	RITTENHOUSE, KARYN	223-7602-563.43-03		HAPRENT-10-22	460.00
30917 - Summary					460.00
30918	ROBINSON, EDWARD (TED)	223-7602-563.43-03		HAPRENT-10-22	454.00
30918 - Summary					454.00
30919	ROBINSON, TRAMAINE	223-7602-563.43-03		HAPRENT-10-22	687.00
30919 - Summary					687.00
30920	RODIEZ, TIM	226-7605-563.43-08		HAPRENT-10-22	1,127.00
30920 - Summary					1,127.00
30921	ROEGLIN, MARY	226-7605-563.43-08		HAPRENT-10-22	660.00
30921 - Summary					660.00
30922	ROGICH, EARL & SHARON	223-7602-563.43-03		HAPRENT-10-22	489.00
30922 - Summary					489.00
30923	ROGOWSKI, DAVID	223-7602-563.43-03		HAPRENT-10-22	650.00
30923 - Summary					650.00
30924	ROTAB LLC	223-7602-563.43-03		HAPRENT-10-22	602.00
30924 - Summary					602.00
30925	ROZMAN, GLORIA	223-7602-563.43-03		HAPRENT-10-22	1,039.00
	ROZMAN, GLORIA	226-7605-563.43-08		HAPRENT-10-22	575.00
30925 - Summary					1,614.00
30926	RUIZ, HECTOR	223-7602-563.43-03		HAPRENT-10-22	891.00
30926 - Summary					891.00
30927	RUPENA, MATTHEW	226-7605-563.43-08		HAPRENT-10-22	2,985.00
30927 - Summary					2,985.00
30928	S. 13TH STREET LLC	226-7605-563.43-08		HAPRENT-10-22	281.00
30928 - Summary					281.00
30929	SCHELL, EVAN	226-7605-563.43-08		HAPRENT-10-22	591.00
30929 - Summary					591.00
30930	SCHMALL, PETER	223-7602-563.43-03		HAPRENT-10-22	548.00
30930 - Summary					548.00
30931	SCHMID, THERESA SCHLUETER	223-7602-563.43-03		HAPRENT-10-22	574.00
30931 - Summary					574.00
30932	SCHUELE, RONALD	223-7602-563.43-03		HAPRENT-10-22	1,049.00
30932 - Summary					1,049.00
30933	SCRIMA, KELLY	223-7602-563.43-03		HAPRENT-10-22	1,024.00
30933 - Summary					1,024.00
30934	SMART ASSET REALTY	223-7602-563.43-03		HAPRENT-10-22	750.00
	SMART ASSET REALTY	226-7605-563.43-08		HAPRENT-10-22	1,099.00
30934 - Summary					1,849.00

Monthly Listing of Claims Paid
October 2022

Check#	Vendor	GL Account	Proj No	Description	Amount
30935	SORMRUDE, JULIAN	223-7602-563.43-03		HAPRENT-10-22	210.00
30935 - Summary					210.00
30936	SOUTHEAST WISCONSIN PROP MGMT	223-7602-563.43-03		HAPRENT-10-22	1,870.00
	SOUTHEAST WISCONSIN PROP MGMT	226-7605-563.43-08		HAPRENT-10-22	631.00
30936 - Summary					2,501.00
30937	STAMOS, JANA	223-7602-563.43-03		HAPRENT-10-22	704.00
30937 - Summary					704.00
30938	STEFANIAK, PETER	223-7602-563.43-03		HAPRENT-10-22	262.00
30938 - Summary					262.00
30939	STEFANOVICH, SUSAN	223-7602-563.43-03		HAPRENT-10-22	603.00
30939 - Summary					603.00
30940	STRYEWA, LLC	223-7602-563.43-03		HAPRENT-10-22	397.00
30940 - Summary					397.00
30941	SUV PROPERTIES LLC	223-7602-563.43-03		HAPRENT-10-22	459.00
30941 - Summary					459.00
30942	S2 REAL ESTATE GROUP 2 LLC	223-7602-563.43-03		HAPRENT-10-22	478.00
30942 - Summary					478.00
30943	TADDEY, RONALD & MARCIA	223-7602-563.43-03		HAPRENT-10-22	475.00
30943 - Summary					475.00
30944	THE BERKSHIRE-WEST ALLIS	223-7602-563.43-03		HAPRENT-10-22	7,625.00
	THE BERKSHIRE-WEST ALLIS	226-7605-563.43-08		HAPRENT-10-22	5,671.00
30944 - Summary					13,296.00
30945	TJH ENTERPRISES, LLC	223-7602-563.43-03		HAPRENT-10-22	484.00
30945 - Summary					484.00
30946	TOOHEY, JOHN JR	223-7602-563.43-03		HAPRENT-10-22	942.00
30946 - Summary					942.00
30947	TWG CLYDE LLC	226-7605-563.43-08		HAPRENT-10-22	571.00
30947 - Summary					571.00
30948	URBAN, JEFFERY	223-7602-563.43-03		HAPRENT-10-22	570.00
30948 - Summary					570.00
30949	VAN DORF, DAVID	223-7602-563.43-03		HAPRENT-10-22	291.00
30949 - Summary					291.00
30950	VIEYRA, MICHAEL	223-7602-563.43-03		HAPRENT-10-22	539.00
30950 - Summary					539.00
30951	VP INVESTORS LLC	223-7602-563.43-03		HAPRENT-10-22	630.00
30951 - Summary					630.00
30952	WE ENERGIES	223-7602-563.43-04		URRENT-10-22	1,042.00
	WE ENERGIES	226-7605-563.43-04		URRENT-10-22	866.00
30952 - Summary					1,908.00
30953	WEINGART, NANCY	223-7602-563.43-03		HAPRENT-10-22	821.00
30953 - Summary					821.00
30954	WELLSTON APARTMENTS	226-7605-563.43-08		HAPRENT-10-22	780.00
30954 - Summary					780.00
30955	WELSH, RICHARD	223-7602-563.43-03		HAPRENT-10-22	732.00
30955 - Summary					732.00
30956	WENKER, GARY	223-7602-563.43-03		HAPRENT-10-22	311.00
30956 - Summary					311.00
30957	WESLEY SCOTT HARMONY HOUSING,	226-7605-563.43-08		HAPRENT-10-22	2,501.00
30957 - Summary					2,501.00
30958	WIESNER, BENJAMIN	223-7602-563.43-03		HAPRENT-10-22	705.00
30958 - Summary					705.00
30959	WIESNER, JOHN	223-7602-563.43-03		HAPRENT-10-22	1,069.00
30959 - Summary					1,069.00
30960	WILLIAM A PASSAVANT LLC	226-7605-563.43-08		HAPRENT-10-22	443.00
30960 - Summary					443.00
30961	WILLIAMSTOWN BAY-CUDAHY LLC	226-7605-563.43-08		HAPRENT-10-22	523.00
30961 - Summary					523.00

**Monthly Listing of Claims Paid
October 2022**

Check#	Vendor	GL Account	Proj No	Description	Amount
30962	WOOD PROPERTY MANAGEMENT, LLC	223-7602-563.43-03		HAPRENT-10-22	621.00
30962 - Summary					621.00
30963	WRIGHT, MEGAN	223-7602-563.43-03		HAPRENT-10-22	542.00
30963 - Summary					542.00
30964	ZAGRODNIK, ROBERT AND DOROTHY	223-7602-563.43-03		HAPRENT-10-22	642.00
30964 - Summary					642.00
30965	ZASTROW, DANIEL	223-7602-563.43-03		HAPRENT-10-22	593.00
30965 - Summary					593.00
30966	ZAWAHIR, BILLIE JO	223-7602-563.43-03		HAPRENT-10-22	524.00
30966 - Summary					524.00
30967	ZOCCOLI, MARCO	223-7602-563.43-03		HAPRENT-10-22	7,244.00
	ZOCCOLI, MARCO	226-7605-563.43-08		HAPRENT-10-22	4,656.00
30967 - Summary					11,900.00
30968	ZORIC, LUKA	223-7602-563.43-03		HAPRENT-10-22	510.00
30968 - Summary					510.00
30969	1422, LLC	223-7602-563.43-03		HAPRENT-10-22	61.00
30969 - Summary					61.00
30970	15 LLC	223-7602-563.43-03		HAPRENT-10-22	446.00
	15 LLC	226-7605-563.43-08		HAPRENT-10-22	799.00
30970 - Summary					1,245.00
30971	2401 S. 92ND ST. LLC	223-7602-563.43-03		HAPRENT-10-22	615.00
30971 - Summary					615.00
30972	2453 N. 17TH ST., LLC	223-7602-563.43-03		HAPRENT-10-22	2,301.00
30972 - Summary					2,301.00
30973	3317-19 WOLLMER LLC	223-7602-563.43-03		HAPRENT-10-22	542.00
30973 - Summary					542.00
30974	5324 W. BELOIT RD LLC	226-7605-563.43-08		HAPRENT-10-22	850.00
30974 - Summary					850.00
10/03/2022 - Summary					255,739.00

Payment Date: 10/06/2022

Check#	Vendor	GL Account	Proj No	Description	Amount
30977	FUEL SYSTEMS INC	100-0000-141.01-00		PO NUM 144797	211.47
30977 - Summary					211.47
30978	GRAINGER	100-0000-141.01-00		PO NUM 144798	243.24
30978 - Summary					243.24
30979	HUMPHREY SERVICE PARTS INC	100-0000-141.01-00		PO NUM 144800	346.32
30979 - Summary					346.32
30980	AB DATA CLIENT TRUST AND MAIL	501-2802-537.51-01		POSTAGE REQ WATER BILLING	4,125.00
	AB DATA CLIENT TRUST AND MAIL	510-3803-536.51-01		POSTAGE REQ WATER BILLING	4,125.00
	AB DATA CLIENT TRUST AND MAIL	540-1807-538.51-01		POSTAGE REQ WATER BILLING	4,125.00
	AB DATA CLIENT TRUST AND MAIL	550-4233-535.51-01		POSTAGE REQ WATER BILLING	4,125.00
30980 - Summary					16,500.00
30981	ALBRECHT, SCOTT	255-8101-521.56-03	I22534	Pittsburgh travel	1,619.48
	ALBRECHT, SCOTT	255-8101-521.56-03	I22534	MN travel	372.88
30981 - Summary					1,992.36
30982	ARING EQUIPMENT COMPANY INC	100-4218-531.44-08		15W40 oil	401.12
	ARING EQUIPMENT COMPANY INC	550-4233-535.44-08		Foot step, plates	257.40
30982 - Summary					658.52
30983	BADGER TRUCK CENTER INC	100-2201-522.44-03		HEAT BLOWER MOTOR/4415	74.55
30983 - Summary					74.55
30984	BOHN, JAMES	255-8101-521.56-03	I22534	Pittsburgh travel	1,533.03
	BOHN, JAMES	255-8101-521.56-03	I22534	07-09, 2022 mileage	121.25
	BOHN, JAMES	255-8101-521.56-03	I22534	EB meeting in MN	642.88
	BOHN, JAMES	255-8101-521.56-03	I22534	June, 2022 mileage	39.78
30984 - Summary					2,336.94
30985	CARRINGTON, DANIELLE	222-7601-563.56-02		D. Carrington WAHA	58.13
30985 - Summary					58.13

**Monthly Listing of Claims Paid
October 2022**

Check#	Vendor	GL Account	Proj No	Description	Amount
30986	CARROLL, RYAN	255-8101-521.30-04	I22538	August, 2022 mileage	255.63
	CARROLL, RYAN	255-8101-521.56-03	I22538	Iowa travel	736.64
30986 - Summary					992.27
30987	CITIES & VILLAGES MUTUAL INS CO	100-5212-517.61-01		21-22 WC Audit Addtl Prem	9,250.00
30987 - Summary					9,250.00
30988	COFFIELD, CARSON	258-3102-565.56-02		Carson - WEDA 9/12-9/15	64.38
30988 - Summary					64.38
30989	COLLINS, GREGG	100-5212-517.30-04		DPW Safety Shoe Reimb.	150.00
30989 - Summary					150.00
30990	COREY OIL LTD	100-4501-533.44-08		Shop Supplies	337.90
	COREY OIL LTD	540-1801-538.44-08		Citgo Pacemaker 150	122.42
30990 - Summary					460.32
30991	DC ELLINGTON COMPANY	100-2201-522.54-02		(2) OCCUPANCY LOAD SIGNS	40.00
30991 - Summary					40.00
30992	DROSEN, ANN	100-0401-512.56-01		supplies	66.71
	DROSEN, ANN	100-0401-512.56-02		Court Seminar 2022 Ann	499.88
30992 - Summary					566.59
30993	FRENCH, ERIC	255-8101-521.56-03	I21536	Memphis travel	19.17
	FRENCH, ERIC	255-8101-521.56-03	I21538	Memphis travel	471.33
30993 - Summary					490.50
30994	GRAINGER	100-4201-535.53-02		For Sanitation - Sara D	196.32
	GRAINGER	540-1801-538.44-08		1/2x36 threaded pipe	53.91
30994 - Summary					250.23
30995	GRILL, REBECCA	100-1001-513.56-02		Denver - Blackbelt Confer	1,339.48
	GRILL, REBECCA	100-5002-517.51-04		Snacks for Admin Meeting.	50.64
30995 - Summary					1,390.12
30996	HIBBARD, DANIELLE	100-2107-521.56-02		REIMBURSE PROPHOENIC CONF	411.25
30996 - Summary					411.25
30997	HOFFMAN, JAMES	255-8101-521.56-03	I22538	July, 2022 mileage	58.75
30997 - Summary					58.75
30998	HUMPHREY SERVICE PARTS INC	100-4218-531.44-08		Repair Parts	99.56
30998 - Summary					99.56
30999	HURLEY, BRANDON	100-2107-521.56-02		IL trn recertification	378.10
30999 - Summary					378.10
31000	KABOSKEY, SCOTT	100-4218-531.58-01		kaboskey cdl renewal	74.00
31000 - Summary					74.00
31001	LINCOLN CONTRACTORS SUPPLY INC	100-2201-522.44-02		REPAIR TO CHAINSAW	37.45
31001 - Summary					37.45
31002	MANZ, TRACY	100-2107-521.56-02		reimburse 22 Prophoenix	411.25
31002 - Summary					411.25
31003	MARTIN, ROBERT	100-5212-517.30-04		DPW Safety Shoe Reimb.	150.00
31003 - Summary					150.00
31004	MORENO, AMY	222-7601-563.56-02		A Moreno WAHA Expenses	108.38
31004 - Summary					108.38
31005	OZINGA READY MIX CONCRETE, INC	100-4218-531.53-02		Exp. joints 1/2x4x5	70.00
31005 - Summary					70.00
31006	PACKERLAND RENT A MAT INC	255-8101-521.30-04	I22534	Mat rental	72.67
31006 - Summary					72.67
31007	RAMBOLL ENVIRON US CORPORATION	258-3102-565.30-02		8001-8113 Natl Ave	405.00
	RAMBOLL ENVIRON US CORPORATION	315-6606-563.30-02	T15010	EPA Revolving Loan	162.50
31007 - Summary					567.50
31008	SAFEWAY PEST CONTROL CO	100-4101-533.41-08		LH-8 xtra rodent bait sta	216.00
	SAFEWAY PEST CONTROL CO	100-4101-533.41-08		LH-extra visits-rat abate	50.00
	SAFEWAY PEST CONTROL CO	100-4101-533.41-08		LH-replace bait station	27.00
	SAFEWAY PEST CONTROL CO	100-4101-533.41-08		LH-extra check-rat abate	50.00
	SAFEWAY PEST CONTROL CO	100-4101-533.41-08		LH-xtra visits(wkly)	50.00
	SAFEWAY PEST CONTROL CO	100-4101-533.41-08		LH-xtra serv(weekly)	50.00
31008 - Summary					443.00

Monthly Listing of Claims Paid
October 2022

Check#	Vendor	GL Account	Proj No	Description	Amount
31009	SCHAER, STEVE	100-2301-523.51-04		Neighborhood Assoc Mixer	114.64
31009 - Summary					114.64
31010	SCHWARTZ, DAN	100-4601-533.14-10		Sept mileage	84.00
31010 - Summary					84.00
31011	SHERWIN INDUSTRIES INC	100-4218-531.44-08		Repair Parts	150.78
	SHERWIN INDUSTRIES INC	100-4218-531.53-02		S5-sand hot mix	272.70
	SHERWIN INDUSTRIES INC	100-4218-531.53-02		2 squeegees	144.00
	SHERWIN INDUSTRIES INC	100-4218-531.53-02		S5	529.20
	SHERWIN INDUSTRIES INC	100-4218-531.53-02		S4	24.42
	SHERWIN INDUSTRIES INC	501-2707-537.53-08		S5	33.75
	SHERWIN INDUSTRIES INC	501-2707-537.53-08		S3	111.00
	SHERWIN INDUSTRIES INC	540-1801-538.53-02		S4	444.00
	SHERWIN INDUSTRIES INC	540-1801-538.53-02		S3	329.67
31011 - Summary					2,039.52
31012	STARK, THOMAS	100-5212-517.30-04		DPW Safety Shoe Reimb.	79.99
31012 - Summary					79.99
31013	STEALTH PARTNER GROUP, LLC	602-9101-517.21-60		Oct Stop Loss premium	78,299.60
31013 - Summary					78,299.60
31014	STRYSICK, ROBERT	100-4601-533.14-10		Sept Mileage	107.25
31014 - Summary					107.25
31015	WE ENERGIES	100-2110-521.41-04		Elec Service	424.02
	WE ENERGIES	100-2110-521.41-04		11301 W Lincoln	20.19
	WE ENERGIES	100-2110-521.41-04		sept wapd electric	7,856.65
	WE ENERGIES	100-2110-521.41-05		Gas Service Vets Pk	15.71
	WE ENERGIES	100-2110-521.41-05		sept gas pd	3,178.33
	WE ENERGIES	100-2201-522.41-04		10830 W Lapham	1,384.25
	WE ENERGIES	100-2201-522.41-04		7332 W Natl	2,084.85
	WE ENERGIES	100-2201-522.41-05		7300 W Natl Gas	212.27
	WE ENERGIES	100-2201-522.41-05		10830 W Lapham Gas	144.60
	WE ENERGIES	100-2201-522.41-05		7332 W Natl Gas	138.90
	WE ENERGIES	100-3001-541.41-04		7120 W Natl Elec	1,080.28
	WE ENERGIES	100-3001-541.41-05		7120 W Natl Gas Serv	109.81
	WE ENERGIES	100-3401-544.41-04		7001 W National Ave.	824.07
	WE ENERGIES	100-3401-544.41-05		7001 W National	174.67
	WE ENERGIES	100-3507-555.41-04		7421 W Natl Elec	4,771.00
	WE ENERGIES	100-3507-555.41-05		7421 W Natl Gas	529.15
	WE ENERGIES	100-4101-533.41-04		Burnham St Park Elec	29.97
	WE ENERGIES	100-4101-533.41-04		1647 S 76 Elec	19.71
	WE ENERGIES	100-4101-533.41-04		1530 S 62 St	393.84
	WE ENERGIES	100-4101-533.41-04		1000 S 72 Elec	39.36
	WE ENERGIES	100-4101-533.41-04		1631 S 96 St Elec	47.52
	WE ENERGIES	100-4101-533.41-04		Elec City Hall	6,042.13
	WE ENERGIES	100-4101-533.41-04		8435 W Natl Elec	39.61
	WE ENERGIES	100-4101-533.41-04		9651 W Lapham	34.80
	WE ENERGIES	100-4101-533.41-04		1718 S 84 St	135.76
	WE ENERGIES	100-4101-533.41-05		1530 S 62 Gas	19.10
	WE ENERGIES	100-4101-533.41-05		Gas Service Cable Room	121.58
	WE ENERGIES	100-4101-533.41-05		8435 W National Ave Gas	10.56
	WE ENERGIES	100-4101-533.41-05		1000 S 72 Gas	9.90
	WE ENERGIES	100-4118-531.41-04		76 and Natl Elec	121.51
	WE ENERGIES	100-4118-531.41-04		6991 W Orchard Elec	31.99
	WE ENERGIES	100-4118-531.41-04		5822 W lapham St Light	145.32
	WE ENERGIES	100-4118-531.41-04		Group Bill	5,920.48
	WE ENERGIES	100-4118-531.41-04		1425 S 71 Elec	23.62
	WE ENERGIES	100-4118-531.41-04		1426 S 74 St Elec	20.16
	WE ENERGIES	100-4118-531.41-04		6133 W Mitchell Elec	213.85
	WE ENERGIES	100-4118-531.41-04		1490 S 85 St	96.94
	WE ENERGIES	100-4118-531.41-04		1422 S 73 Elec	49.47
	WE ENERGIES	100-4201-535.41-04		3601 S 116 St	63.05
	WE ENERGIES	100-4201-535.41-04		11401 W Lincoln Ave	38.29
	WE ENERGIES	100-5007-552.41-04		MARket Elec	303.10
	WE ENERGIES	305-6606-563.31-02		6424 W Greenfield	17.33
	WE ENERGIES	305-6606-563.31-02		6426 W GF Gas	10.56

**Monthly Listing of Claims Paid
October 2022**

Check#	Vendor	GL Account	Proj No	Description	Amount
31015	WE ENERGIES	305-6606-563.31-02		6426 W Greenfield	41.82
	WE ENERGIES	501-2601-537.41-04		1725 S 96 Elec	42.04
	WE ENERGIES	501-2601-537.41-04		801 S 77 St	30.19
	WE ENERGIES	501-2601-537.41-04		5536 W National Ave.	39.01
	WE ENERGIES	501-2601-537.41-05		1725 S 96 ST Gas	31.53
	WE ENERGIES	501-2601-537.41-05		1981 S 84 St	11.79
	WE ENERGIES	510-3801-536.41-04		7012 W Burnham	23.04
	WE ENERGIES	540-1801-538.41-04		2179 S 111 St	385.80
	WE ENERGIES	540-1801-538.41-05		2179 S 111 St Gas	19.80
31015 - Summary					37,573.28
31016	ZINNECKER, MATTHEW	100-4601-533.14-10		Aug/Sept mileage	125.50
31016 - Summary					125.50
186052	AFLAC	100-0000-202.14-01		PAYROLL SUMMARY	54.77
186052 - Summary					54.77
186053	AIRGAS USA LLC	100-0000-141.01-00		PO NUM 144784	647.53
	AIRGAS USA LLC	100-0000-141.01-00		PO# 144784	241.60
186053 - Summary					889.13
186054	ALSTAR COMPANY	100-0000-141.01-00		PO NUM 145030	547.89
	ALSTAR COMPANY	100-0000-141.01-00		PO NUM 145029	575.71
186054 - Summary					1,123.60
186055	AUTO PARTS & SERVICE INC	100-0000-141.01-00		PO NUM 144786	446.40
186055 - Summary					446.40
186056	B & H INDUSTRIES, INC	100-4218-531.44-08		Repair Parts	850.00
186056 - Summary					850.00
186057	BARCODESINC	100-2501-515.44-01		PO# 144842	50.26
	BARCODESINC	100-2501-515.44-01		COMPUTER HDWR, PC	591.02
186057 - Summary					641.28
186058	BOWER'S PRODUCE	100-5007-552.38-01		SEPTEMBER SNAP TOKENS	477.00
	BOWER'S PRODUCE	100-5007-552.38-02		SEPTEMBER MMM COUPONS	449.00
186058 - Summary					926.00
186059	BRO-TEX INC	100-0000-141.01-00		PO NUM 145031	1,263.15
186059 - Summary					1,263.15
186060	CCP INDUSTRIES	501-0000-141.01-00		PO NUM 145023	1,483.64
186060 - Summary					1,483.64
186061	CE FARMS	100-5007-552.38-01		SEPTEMBER SNAP TOKENS	78.00
	CE FARMS	100-5007-552.38-02		SEPTEMBER MMM COUPONS	60.00
186061 - Summary					138.00
186062	CENTGRAF FARMS	100-5007-552.38-01		SEPTEMBER SNAP TOKENS	430.00
	CENTGRAF FARMS	100-5007-552.38-02		SEPTEMBER MMM COUPONS	279.00
186062 - Summary					709.00
186063	CINDY'S GREENHOUSE AND FRESH	100-5007-552.38-01		SEPTEMBER SNAP TOKENS	923.00
	CINDY'S GREENHOUSE AND FRESH	100-5007-552.38-02		SEPTEMBER MMM COUPONS	677.00
186063 - Summary					1,600.00
186064	CITY OF WEST ALLIS	100-0000-202.07-00		PAYROLL SUMMARY	126.00
186064 - Summary					126.00
186065	CORE AND MAIN	100-0000-141.01-00		PO NUM 144789	90.92
	CORE AND MAIN	501-0000-141.01-00		PO NUM 144789	787.03
186065 - Summary					877.95
186066	DOBBERSTEIN LAW FIRM, LLC	100-0000-202.07-00		B TAKACH #2010SC004072	24.87
186066 - Summary					24.87
186067	ERTL, JOSEPH	100-5007-552.38-01		SEPTEMBER SNAP TOKENS	256.00
	ERTL, JOSEPH	100-5007-552.38-02		SEPTEMBER MMM COUPONS	180.00
186067 - Summary					436.00
186068	FASTENAL COMPANY	100-0000-141.01-00		PO NUM 144795	401.31
186068 - Summary					401.31
186069	FER-LI MEATS & SAUSAGE LLC	100-5007-552.38-01		SEPTEMBER SNAP TOKENS	526.00
186069 - Summary					526.00
186070	FRANTZ CO INC	100-0000-141.01-00		PO NUM 145032	547.20
186070 - Summary					547.20

**Monthly Listing of Claims Paid
October 2022**

Check#	Vendor	GL Account	Proj No	Description	Amount
186071	GOODYEAR COMMERCIAL TIRE & SERVICE	100-0000-141.01-00		PO NUM 144817	2,433.00
186071 - Summary					2,433.00
186072	HERTHER, DAVID	100-5007-552.38-01		SEPTEMBER SNAP TOKENS	205.00
	HERTHER, DAVID	100-5007-552.38-02		SEPTEMBER MMM COUPONS	198.00
186072 - Summary					403.00
186073	HOEKSTRA'S MARKET & GREENHOUSE	100-5007-552.38-01		SEPTEMBER SNAP TOKENS	589.00
	HOEKSTRA'S MARKET & GREENHOUSE	100-5007-552.38-02		SEPTEMBER MMM COUPONS	460.00
186073 - Summary					1,049.00
186074	JERRY'S PRODUCE LLC	100-5007-552.38-01		SEPTEMBER SNAP TOKENS	282.00
	JERRY'S PRODUCE LLC	100-5007-552.38-02		SEPTEMBER MMM COUPONS	143.00
186074 - Summary					425.00
186075	JOHNSON'S VEGETABLES	100-5007-552.38-01		SEPTEMBER SNAP TOKENS	156.00
	JOHNSON'S VEGETABLES	100-5007-552.38-02		SEPTEMBER MMM COUPONS	164.00
186075 - Summary					320.00
186076	JX PETERBILT -WAUKESHA	100-0000-141.01-00		PO NUM 144801	548.00
186076 - Summary					548.00
186077	KAESTNER AUTO ELECTRIC CO	100-0000-141.01-00		PO NUM 144802	168.75
186077 - Summary					168.75
186078	KRAUS, RICHARD AND SUSAN	100-5007-552.38-01		SEPTEMBER SNAP TOKENS	97.00
	KRAUS, RICHARD AND SUSAN	100-5007-552.38-02		SEPTEMBER MMM COUPONS	73.00
186078 - Summary					170.00
186079	KROKOWSKI'S FARM LLC	100-5007-552.38-01		SEPTEMBER SNAP TOKENS	164.00
186079 - Summary					164.00
186080	MACQUEEN EQUIPMENT	100-0000-141.01-00		PO NUM 145027	271.52
186080 - Summary					271.52
186081	MCKESSON MEDICAL-SURGICAL	240-7913-542.53-41	H23014	HOSPITAL,SURGICAL,&RELATE	15.00
186081 - Summary					15.00
186082	MERCURY DISTRIBUTING -CHILD SOURCE	240-7940-542.53-41	H22035	PO# 144907	634.08
186082 - Summary					634.08
186083	NAPA AUTO PARTS- WEST ALLIS	100-0000-141.01-00		PO NUM 144816	234.57
186083 - Summary					234.57
186084	NATIONAL AUTO FLEET GROUP	100-2101-521.70-02		AUTOS, BUSES, SUVS & VANS	38,830.98
186084 - Summary					38,830.98
186085	NAUNHEIM, MICHAEL	501-0000-229.05-00		MANUAL CHECK	185.34
186085 - Summary					185.34
186086	PDQ.COM CORPORATION	255-8101-521.30-04	I22549	DATA PROC:COMPUTER&SOFTWA	2,100.00
186086 - Summary					2,100.00
186087	POLKA DOT PRODUCE	100-5007-552.38-01		SEPTEMBER SNAP TOKENS	213.00
	POLKA DOT PRODUCE	100-5007-552.38-02		SEPTEMBER MMM COUPONS	209.00
186087 - Summary					422.00
186088	POLZIN FARMS	100-5007-552.38-01		SEPTEMBER SNAP TOKENS	184.00
	POLZIN FARMS	100-5007-552.38-02		SEPTEMBER MMM COUPONS	16.00
186088 - Summary					200.00
186089	POMP'S TIRE SERVICE INC	100-0000-141.01-00		PO NUM 144806	149.25
186089 - Summary					149.25
186090	R. S. PAINT & TOOLS LLC	501-0000-141.01-00		PO NUM 144807	98.64
186090 - Summary					98.64
186091	RIVER VALLEY RANCH LTD	100-5007-552.38-01		SEPTEMBER SNAP TOKENS	70.00
	RIVER VALLEY RANCH LTD	100-5007-552.38-02		SEPTEMBER MMM COUPONS	37.00
186091 - Summary					107.00
186092	SALAMONE SUPPLIES	100-0000-141.01-00		PO NUM 144808	319.90
186092 - Summary					319.90
186093	SCHOLBE FARMS	100-5007-552.38-01		SEPTEMBER SNAP TOKENS	41.00
	SCHOLBE FARMS	100-5007-552.38-02		SEPTEMBER MMM COUPONS	68.00
186093 - Summary					109.00
186094	TAPCO	100-0000-141.01-00		PO NUM 144814	1,078.72
186094 - Summary					1,078.72
186095	UNITED WAY - MILWAUKEE	100-0000-202.09-00		PAYROLL SUMMARY	396.12

Monthly Listing of Claims Paid
October 2022

Check#	Vendor	GL Account	Proj No	Description	Amount
186095	UNITED WAY - MILWAUKEE	100-0000-202.09-00		PAYROLL 8/26	396.12
186095 - Summary					792.24
186096	VANG, SENG	100-5007-552.38-01		SEPTEMBER SNAP TOKENS	89.00
	VANG, SENG	100-5007-552.38-02		SEPTEMBER MMM COUPONS	63.00
186096 - Summary					152.00
186097	VERMEER-WISCONSIN INC	100-0000-141.01-00		PO NUM 145028	1,341.60
186097 - Summary					1,341.60
186098	WAPPA-PAC	100-0000-202.15-00		PAYROLL SUMMARY	26.00
186098 - Summary					26.00
186099	WEST ALLIS PROFESSIONAL POLICE	100-0000-202.08-00		PAYROLL SUMMARY	2,769.16
186099 - Summary					2,769.16
186100	XIONG'S PRODUCE	100-5007-552.38-01		July SNAP tokens	120.00
	XIONG'S PRODUCE	100-5007-552.38-01		AUGUST SNAP TOKENS	27.00
	XIONG'S PRODUCE	100-5007-552.38-02		AUGUST MMM COUPONS	14.00
186100 - Summary					161.00
186101	YANG, CHUE GE	100-5007-552.38-01		SEPTEMBER SNAP TOKENS	109.00
	YANG, CHUE GE	100-5007-552.38-02		SEPTEMBER MMM COUPONS	125.00
186101 - Summary					234.00
186102	YANG, PANG	100-5007-552.38-01		SEPTEMBER SNAP TOKENS	145.00
	YANG, PANG	100-5007-552.38-02		SEPTEMBER MMM COUPONS	203.00
186102 - Summary					348.00
186103	A CUSTOM TO ROOFING AND GUTTERS LLC	396-6307-563.31-67		Payment to contractor	12,958.00
186103 - Summary					12,958.00
186104	AA SECURITY & MONITORING	255-8101-521.30-04	I22538	GPS service	1,260.00
186104 - Summary					1,260.00
186105	AIRGAS USA LLC	100-4101-533.53-02		Cylinder Rental-9/22	37.66
	AIRGAS USA LLC	100-4501-533.44-08		Cylinder Rental 9/2022	1,129.93
	AIRGAS USA LLC	501-2601-537.53-22		Cylinder Rental 9/22	37.66
186105 - Summary					1,205.25
186106	ALSTAR COMPANY	100-4501-533.44-08		Repair Parts Fuel Island	122.40
	ALSTAR COMPANY	501-2901-537.44-03		Repair Parts	276.38
186106 - Summary					398.78
186107	ANTAEUS LLC	100-2501-515.30-04		AUGUST ANTAEUS INV	300.00
186107 - Summary					300.00
186108	ARMSTRONG, SHAY	201-5101-517.30-04		FTF Face Painting	450.00
186108 - Summary					450.00
186109	AT & T LONG DISTANCE	255-8101-521.30-04	I22538	Pen 2929	675.00
	AT & T LONG DISTANCE	255-8101-521.30-04	I22538	PEN 0761	1,700.00
186109 - Summary					2,375.00
186110	AT&T	100-1101-517.41-06		Senior Cntr - Aug	96.21
186110 - Summary					96.21
186111	AURORA HEALTH CARE	100-2001-523.59-01		new hire med evals	2,073.50
	AURORA HEALTH CARE	100-2101-521.30-04		july/aug blood draws	850.00
186111 - Summary					2,923.50
186112	BADGER METER INC	501-2709-537.71-05		107-8755, Qty 12; Freight	1,766.04
	BADGER METER INC	501-2709-537.71-05		107-8745, Qty 12	1,784.64
186112 - Summary					3,550.68
186113	BATTERIES PLUS BULBS	100-4118-531.53-02		3V LITHIUM CR2016	21.45
186113 - Summary					21.45
186114	BAXTER & WOODMAN	501-2901-537.30-02		MWW 2021 Rate Case Assist	2,003.44
186114 - Summary					2,003.44
186115	BILL'S POWER CENTER INC	100-4301-533.44-08		Clutch	41.38
	BILL'S POWER CENTER INC	100-4301-533.44-08		Repair Parts	43.75
186115 - Summary					85.13
186116	BMO HARRIS BANK, NA	100-2101-521.30-04		Record check fee	32.77
186116 - Summary					32.77
186117	BOARDMAN & CLARK, LLP	501-0000-229.17-01		T-MOBILE 84 & NATIONAL	459.50
	BOARDMAN & CLARK, LLP	501-0000-449.09-00		T-MOBILE 84 & NATIONAL	(459.50)

**Monthly Listing of Claims Paid
October 2022**

Check#	Vendor	GL Account	Proj No	Description	Amount
186117	BOARDMAN & CLARK, LLP	501-2706-537.30-02		T-MOBILE 84 & NATIONAL	459.50
186117 - Summary					459.50
186118	BOND TRUST SERVICES CORPORATION	401-4801-571.80-04		2022A Paying Agent Fee	736.00
186118 - Summary					736.00
186119	BOUND TREE MEDICAL LLC	100-2201-522.53-41		MEDICAL SUPPLIES/ST 62	394.59
	BOUND TREE MEDICAL LLC	100-2201-522.53-41		MEDICAL SUPPLIES/ST 61	511.70
186119 - Summary					906.29
186120	BUTTERS-FETTING CO INC	100-4101-533.44-08		Sen Center-AC repair	535.76
186120 - Summary					535.76
186121	CARE-PLUS DENTAL PLANS INC	100-5211-517.21-70		CarePlus Nov premiums	18,960.16
186121 - Summary					18,960.16
186122	CDW-G	255-8101-521.30-04	I22549	Cisco SmrtNt serv agmnt	2,988.00
	CDW-G	255-8101-521.30-04	I22549	Cisco Direct Lic.	1,650.00
	CDW-G	255-8101-521.51-09	I20536	Axis camera	426.22
	CDW-G	255-8101-521.51-09	I22549	Copier toner	481.88
	CDW-G	255-8101-521.51-09	I22549	Axis camera	426.22
186122 - Summary					5,972.32
186123	CENGAGE LEARNING INC	100-3502-555.52-27		INVOICE #79256402	47.98
	CENGAGE LEARNING INC	100-3502-555.52-27		INVOICE #79137174	70.39
186123 - Summary					118.37
186124	CERTAPRO PAINTERS	396-6307-563.31-67		Payment to contractor	463.73
186124 - Summary					463.73
186125	CHARTER COMMUNICATIONS	255-8101-521.30-04	I22549	Internet access	183.52
186125 - Summary					183.52
186126	CINTAS CORPORATION NO. 2	100-2101-521.51-07		mat/uniforms 092222	100.47
	CINTAS CORPORATION NO. 2	100-2101-521.51-07		Mops and Mats	102.20
	CINTAS CORPORATION NO. 2	100-2101-521.51-07		090822 mat/uniforms	100.47
	CINTAS CORPORATION NO. 2	100-2101-521.51-07		091522 mats/uniforms	87.62
	CINTAS CORPORATION NO. 2	100-2201-522.51-07		Mops and towels	80.38
	CINTAS CORPORATION NO. 2	100-3001-541.51-06		Mops 9/29/22	7.06
	CINTAS CORPORATION NO. 2	100-4101-533.51-09		Mops 9/29/22	10.24
	CINTAS CORPORATION NO. 2	100-4101-533.51-09		CRT and Uniform	51.09
	CINTAS CORPORATION NO. 2	100-4101-533.51-09		CRT Cabinet 9/23/22	9.67
	CINTAS CORPORATION NO. 2	100-4101-533.51-09		CRT and Uniform 9/15/22	51.09
	CINTAS CORPORATION NO. 2	100-4101-533.51-09		CRT and uniform 9/29	26.79
	CINTAS CORPORATION NO. 2	100-4101-533.51-09		CRT and coveralls 9/8/22	51.09
	CINTAS CORPORATION NO. 2	100-4101-533.51-09		CRT and Mop 9/9/22	9.67
	CINTAS CORPORATION NO. 2	100-4101-533.51-09		Mats 9/23/22	114.27
	CINTAS CORPORATION NO. 2	100-4101-533.51-09		Mats 9/9/22	122.45
	CINTAS CORPORATION NO. 2	100-4101-533.51-09		Mat 9/29/22	22.71
	CINTAS CORPORATION NO. 2	100-4118-531.51-09		Mop and Mat 9/15	8.75
	CINTAS CORPORATION NO. 2	100-4201-535.51-09		Uniforms 9/15/22	18.23
	CINTAS CORPORATION NO. 2	100-4201-535.51-09		Uniforms 9/22/22	18.23
	CINTAS CORPORATION NO. 2	100-4201-535.51-09		Uniforms 9/29/22	18.23
	CINTAS CORPORATION NO. 2	100-4201-535.51-09		Uniforms 9/8/22	18.23
	CINTAS CORPORATION NO. 2	100-4501-533.51-09		Uniforms 9/22/22	192.76
	CINTAS CORPORATION NO. 2	100-4501-533.51-09		Uniforms 9/8/22	197.62
	CINTAS CORPORATION NO. 2	100-4501-533.51-09		Uniforms 9/29/22	174.38
	CINTAS CORPORATION NO. 2	100-4501-533.51-09		Uniforms 9/15/22	195.54
	CINTAS CORPORATION NO. 2	501-2601-537.51-07		Uniforms 9/15/22	46.45
	CINTAS CORPORATION NO. 2	501-2601-537.51-07		Uniforms 9/8/22	46.45
	CINTAS CORPORATION NO. 2	501-2601-537.51-07		Uniforms 9/22/22	46.45
	CINTAS CORPORATION NO. 2	501-2601-537.51-07		Uniforms 9/29/22	46.45
186126 - Summary					1,975.04
186127	CINTAS FIRE PROTECTION	100-4101-533.32-04		pd semi fire alarm insp	295.32
	CINTAS FIRE PROTECTION	100-4101-533.32-04		Fire #1-Kitchen insp	223.87
	CINTAS FIRE PROTECTION	100-4101-533.32-04		pd anul qrtrly spklr insp	434.32
186127 - Summary					953.51
186128	CIRCA	100-1301-517.54-02		Job posting boosts	142.50
	CIRCA	100-1301-517.54-02		Job Posting Subscription	8,805.00
186128 - Summary					8,947.50

**Monthly Listing of Claims Paid
October 2022**

Check#	Vendor	GL Account	Proj No	Description	Amount
186129	CITY OF WEST ALLIS	100-8803-517.62-02		Res. PPT 20 & 21 #27772	205.77
186129 - Summary					205.77
186130	CLERK OF CIRCUIT COURT	100-0302-516.30-05		E-File account refill	2,000.00
186130 - Summary					2,000.00
186131	CORE AND MAIN	501-2707-537.44-56		BELL JT REP CLP EPXY;FRGT	2,112.81
	CORE AND MAIN	501-2710-537.44-60		SPLIT MEGALUG, QTY 2	224.10
186131 - Summary					2,336.91
186132	COUNTY MATERIALS CORP	100-0000-141.01-00		PO NUM 144891	600.00
	COUNTY MATERIALS CORP	540-1801-538.53-02		CBs	5,064.00
	COUNTY MATERIALS CORP	540-1801-538.53-14		PO-BLANKET	(729.84)
186132 - Summary					4,934.16
186133	CRAWDADDY'S ON GREENFIELD	200-1901-565.31-02		Artscape Mural	4,350.00
186133 - Summary					4,350.00
186134	CRESCENT ELECTRIC SUPPLY COMPANY	100-4118-531.53-02		5PK ARC FLASH LBL	44.70
	CRESCENT ELECTRIC SUPPLY COMPANY	100-4118-531.53-02		6-32 MACHINE SCREW KIT	57.38
	CRESCENT ELECTRIC SUPPLY COMPANY	100-4118-531.53-02		RT BOX-2 GANG, 3 HOLE	24.01
	CRESCENT ELECTRIC SUPPLY COMPANY	501-2706-537.44-54		20A 2 POLE BREAKER	27.98
	CRESCENT ELECTRIC SUPPLY COMPANY	501-2706-537.44-54		Switch and GFCI	19.39
186134 - Summary					173.46
186135	CUMMINS SALES AND SERVICE	100-2201-522.44-03		OIL PRESSURE PLUG/#4211	39.94
	CUMMINS SALES AND SERVICE	100-2201-522.44-03		SENSOR/#4211	120.93
186135 - Summary					160.87
186136	Donald Dougherty	100-0000-429.11-00		TPEP Refund - Dougherty	185.00
186136 - Summary					185.00
186137	DAVIS INSTRUMENT CO INC	100-3003-541.44-08		BP CALIBRATION	647.25
186137 - Summary					647.25
186138	DON'S AUTO BODY	100-2110-521.44-03		sqd 63 repairs	574.08
	DON'S AUTO BODY	100-2110-521.44-03		sqd 28 repairs	640.00
186138 - Summary					1,214.08
186139	DONOHUE & ASSOCIATES INC	354-6053-523.31-02	BF0027	Police & Court Generator	592.50
186139 - Summary					592.50
186140	DOYNE, SHAUN	255-8101-521.56-03	I22538	Des Moines travel	529.89
186140 - Summary					529.89
186141	DRIES, JOHN	100-0302-516.30-16		Spec Admin-2340 S 78th St	1,000.00
186141 - Summary					1,000.00
186142	DUNN'S SPORTING GOODS	100-4001-533.30-04		PW and logo on front	135.20
186142 - Summary					135.20
186143	EDWARD H. WOLF & SONS, INC.	100-4501-533.53-01		Diesel & Unleaded fuel	27,740.41
186143 - Summary					27,740.41
186144	EHLERS & ASSOCIATES INC	311-6606-563.30-04	T11010	Ehlers-TID 11 model	487.50
	EHLERS & ASSOCIATES INC	315-6606-563.30-04	T15010	Ehlers-TID 15 model	650.00
186144 - Summary					1,137.50
186145	ELLIOTT'S ACE HARDWARE	100-2201-522.44-02		SAWZALL BLADES/TL62	85.96
	ELLIOTT'S ACE HARDWARE	100-2201-522.44-08		MISC BLDG/OFFICE REPAIRS	74.08
	ELLIOTT'S ACE HARDWARE	100-2201-522.51-08		MISC SHOP SUPPLIES/ST 62	63.26
	ELLIOTT'S ACE HARDWARE	217-0901-522.64-05	FR0005	ST 63/SPIN BIKE REPAIR	0.38
186145 - Summary					223.68
186146	EMERGENCY LIGHTING &	100-2201-522.44-03		EMERGENCY LIGHT AMPLIFIER	100.00
186146 - Summary					100.00
186147	FEDEX	255-8101-521.30-04	I22534	Shipping	5.92
186147 - Summary					5.92
186148	FITNESS TECHS	217-0901-522.64-05	FR0005	FIRE ADMIN FITNESS	169.00
	FITNESS TECHS	217-0901-522.64-05	FR0005	STATION 63 FITNESS	100.00
	FITNESS TECHS	217-0901-522.64-05	FR0005	ADMINISTRATION/FITNESS	408.00
	FITNESS TECHS	217-0901-522.64-05	FR0005	TREADMILL REPAIR/FIRE ADM	670.00
186148 - Summary					1,347.00
186149	FRANKLIN AGGREGATES INC	501-2707-537.44-56		3/8 chips	698.38
	FRANKLIN AGGREGATES INC	501-2708-537.44-57		3/8 chips	698.38
186149 - Summary					1,396.76

**Monthly Listing of Claims Paid
October 2022**

Check#	Vendor	GL Account	Proj No	Description	Amount
186150	GRANICUS INC	100-1501-517.30-04		Annual Granicus	18,168.38
186150 - Summary					18,168.38
186151	GRAPHIC INNOVATIONS, LLC	100-5002-517.51-09		Food Truck Fridays Banner	420.00
186151 - Summary					420.00
186152	GRAYBAR	354-6051-517.31-02	M2220M	BUSS FUSEHOLDER	627.20
186152 - Summary					627.20
186153	GREBE'S BAKERIES, INC	273-8453-563.31-02	CV2003	Loan - Covid Funds	100,000.00
186153 - Summary					100,000.00
186154	GREGORY, ROBERT	255-8101-521.56-03	I21536	Memphis travel	234.49
	GREGORY, ROBERT	255-8101-521.56-03	I21546	Memphis travel	190.00
	GREGORY, ROBERT	255-8101-521.56-03	I21548	Memphis travel	99.87
186154 - Summary					524.36
186155	HILLER FORD INC	100-2110-521.44-03		squad 12 parts	47.58
	HILLER FORD INC	100-2110-521.44-03		squad parts	991.51
	HILLER FORD INC	100-2110-521.44-03		returned squad part/credi	(83.88)
	HILLER FORD INC	100-2110-521.44-03		squad repairs	3,036.96
	HILLER FORD INC	100-2110-521.44-03		squad aprts	365.27
	HILLER FORD INC	100-2110-521.44-03		squad 47 parts	129.56
	HILLER FORD INC	100-2110-521.44-03		return squad parts	(292.60)
186155 - Summary					4,194.40
186156	HYDRAULIC COMPONENT SERVICES	100-4301-533.44-08		Hydro Pump Rebuild	2,765.89
	HYDRAULIC COMPONENT SERVICES	100-4501-533.44-08		Cylinder Repair	2,154.28
186156 - Summary					4,920.17
186157	J.H. MEDINGER INC	100-4218-531.44-08		Misc. engine parts	119.85
	J.H. MEDINGER INC	100-4301-533.44-08		Wheels (4)	73.92
186157 - Summary					193.77
186158	Joe DeBelak Plumbing & Heating Co.	100-0000-229.04-00		2450 S 68 St	2,590.93
186158 - Summary					2,590.93
186159	Jonathan Teeters	100-0000-229.04-00		2020 S 78 ST	100.00
186159 - Summary					100.00
186160	JX PETERBILT -WAUKESHA	100-4201-535.44-08		Credit 826-warranty	(1,402.62)
	JX PETERBILT -WAUKESHA	100-4201-535.44-08		Valve-solenoid	90.99
	JX PETERBILT -WAUKESHA	100-4201-535.44-08		Repair-will be covrd warr	2,704.98
	JX PETERBILT -WAUKESHA	100-4201-535.44-08		Warranty Credit 826	(1,302.36)
	JX PETERBILT -WAUKESHA	550-4233-535.44-08		Repair Parts	44.99
186160 - Summary					135.98
186161	KIRBY, SCOTT	201-5101-517.30-04		Food Truck Friday Music	200.00
186161 - Summary					200.00
186162	KL ENGINEERING	354-6051-517.31-02	M2220M	Lighting Circuit Upgrades	28,625.43
186162 - Summary					28,625.43
186163	LAKESIDE INTERNATIONAL TRUCKS INC	100-2201-522.44-03		AIR BAG/#4416	172.30
	LAKESIDE INTERNATIONAL TRUCKS INC	100-4218-531.44-08		Return Credit	(363.10)
	LAKESIDE INTERNATIONAL TRUCKS INC	100-4218-531.44-08		Repair Parts	206.93
	LAKESIDE INTERNATIONAL TRUCKS INC	550-4233-535.44-08		Repair Parts	1,041.65
	LAKESIDE INTERNATIONAL TRUCKS INC	550-4233-535.44-08		Fuel filter	122.48
186163 - Summary					1,180.26
186164	LALONDE CONTRACTORS INC	350-6008-531.31-01	P2234S	Mitchell 92-96 Streets	242,586.10
	LALONDE CONTRACTORS INC	501-2901-537.75-01	P2234H	Mitchell 92-96 Water	22,610.00
	LALONDE CONTRACTORS INC	540-1807-538.75-01	P2234G	Mitchell 92-96 Green Infr	4,137.25
	LALONDE CONTRACTORS INC	540-1807-538.75-01	P2234R	Mitchell 92-96 Storm	17,867.60
186164 - Summary					287,200.95
186165	LEE MECHANICAL	100-4101-533.44-08		PD-HVAC repair	245.00
	LEE MECHANICAL	100-4101-533.53-02		HVAC-PD-PM boilers	1,590.81
186165 - Summary					1,835.81
186166	LIFE-ASSIST, INC	100-2201-522.53-41		MEDICAL SUPPLIES	2,227.00
	LIFE-ASSIST, INC	100-2201-522.53-41		MEDICAL SUPPLIES/ST 62	93.45
	LIFE-ASSIST, INC	100-2201-522.53-41		MEDICAL SUPPLIES/ST 61	1,511.24
186166 - Summary					3,831.69
186167	LIFELINE SYSTEMS	100-0000-442.03-07		August 2022 Lifequest	29,417.43
	LIFELINE SYSTEMS	100-0000-442.03-11		August 2022 MVA	824.91

**Monthly Listing of Claims Paid
October 2022**

Check#	Vendor	GL Account	Proj No	Description	Amount
186167	Summary				30,242.34
186168	MAXIM HEALTHCARE STAFFING, INC	240-7937-542.30-03	EF2105	SEPTEMBER VACCINATION	805.00
186168	Summary				805.00
186169	MEDICAL COLLEGE OF WI	240-7915-542.31-02	H19101	AUGUST CARDIFF	33,867.05
	MEDICAL COLLEGE OF WI	240-7915-542.31-02	H19101	JULY- CARDIFF	16,661.41
186169	Summary				50,528.46
186170	MEGA LLC	100-2201-522.51-04		2022 INTERN FOOD CARDS	280.00
186170	Summary				280.00
186171	MELOTT, SUSAN	100-3501-555.30-04		Restorative Yoga and Medi	40.00
186171	Summary				40.00
186172	MENARDS - WEST ALLIS	100-2201-522.44-08		SINK REPAIR/ST 61	29.47
	MENARDS - WEST ALLIS	100-4118-531.53-02		GREENFIELD OUTLETS	45.23
	MENARDS - WEST ALLIS	501-2901-537.51-06		18 SQUEEGEE	7.49
	MENARDS - WEST ALLIS	501-2901-537.51-06		12 SQUEEGEE	5.97
	MENARDS - WEST ALLIS	501-2901-537.51-08		LADDER,MAT,PLIERS,EXTCORD	224.90
186172	Summary				313.06
186173	MEREDITH, BRUCE	255-8101-521.30-04	I22549	LastPass subscription	1,440.00
186173	Summary				1,440.00
186174	MIDWEST TAPE	100-3502-555.52-22		INVOICE #502695559	224.95
186174	Summary				224.95
186175	MILWAUKEE AREA TECHNICAL COLLEGE	100-2201-522.57-02		(3) MATC INTERNS	1,451.25
186175	Summary				1,451.25
186176	MILWAUKEE COUNTY CLERK OF COURTS	100-0000-229.11-10		bail	1,500.00
186176	Summary				1,500.00
186177	MILWAUKEE COUNTY TREASURER	100-0000-451.01-00		August Court Fines	7,382.28
186177	Summary				7,382.28
186178	MJ CONSTRUCTION INC	502-2901-537.31-01	DNR005	Private Prop Work-DNR	90,799.10
	MJ CONSTRUCTION INC	510-3803-536.75-01	MMSD10	Private Prop Work-MMSD	107,021.30
186178	Summary				197,820.40
186179	MOODY'S INVESTOR SERVICE	401-4801-571.80-04		Moody's rating 2022	14,000.00
186179	Summary				14,000.00
186180	NAPA AUTO PARTS- WEST ALLIS	100-2201-522.44-03		AC BELT/#4211	80.03
	NAPA AUTO PARTS- WEST ALLIS	100-2201-522.44-03		FLEET MAINTENANCE #4208	47.95
	NAPA AUTO PARTS- WEST ALLIS	100-2401-524.44-03		Repair Parts	60.59
	NAPA AUTO PARTS- WEST ALLIS	100-4218-531.44-08		Hydraulic filter	87.14
	NAPA AUTO PARTS- WEST ALLIS	100-4218-531.44-08		Hydraulic & oil filter	38.67
	NAPA AUTO PARTS- WEST ALLIS	100-4218-531.44-08		Diesel exhaust filter	71.99
	NAPA AUTO PARTS- WEST ALLIS	100-4218-531.44-08		Return Credit	(70.99)
	NAPA AUTO PARTS- WEST ALLIS	100-4301-533.44-08		EGR valve	151.22
	NAPA AUTO PARTS- WEST ALLIS	100-4501-533.44-08		Warranty and Core Credit	(191.11)
	NAPA AUTO PARTS- WEST ALLIS	100-4501-533.44-08		Repair Parts	297.78
	NAPA AUTO PARTS- WEST ALLIS	501-2901-537.44-03		Water pump & belt	265.93
	NAPA AUTO PARTS- WEST ALLIS	550-4233-535.44-08		Hydraulic breather filter	28.08
	NAPA AUTO PARTS- WEST ALLIS	550-4233-535.44-08		Air filter	112.31
	NAPA AUTO PARTS- WEST ALLIS	550-4233-535.44-08		Repair Parts	47.40
	NAPA AUTO PARTS- WEST ALLIS	550-4233-535.44-08		Tiger hair fiberglass rpr	62.49
186180	Summary				1,089.48
186181	NETWORK HEALTH ADMIN SERVICES, LLC	603-9130-517.21-83		RET Jun-Aug SS fee	10,794.15
	NETWORK HEALTH ADMIN SERVICES, LLC	603-9130-517.21-83		Jun-Aug shared saving fee	22,799.74
186181	Summary				33,593.89
186182	NEW BERLIN REDI-MIX	100-4218-531.53-02		7 bag #1 stone with air	546.00
	NEW BERLIN REDI-MIX	501-2707-537.53-08		7 bag #1 stone with air	1,908.50
	NEW BERLIN REDI-MIX	540-1801-538.53-02		7 bag #1 stone with air	275.50
186182	Summary				2,730.00
186183	PARANORMAL INVESTIGATORS OF MILW	100-3501-555.30-04		INVOICE #0930202202	200.00
186183	Summary				200.00
186184	PAUL CONWAY SHIELDS	100-2201-522.60-01		BOOTS/LISKA, SCOTT	552.93
186184	Summary				552.93
186185	PITNEY BOWES PURCHASE POWER	260-8201-517.51-01		postage purchase power up	39.98

**Monthly Listing of Claims Paid
October 2022**

Check#	Vendor	GL Account	Proj No	Description	Amount
186185	Summary				39.98
186186	PRIORITY DISPATCH CORPORATION	100-2201-522.32-01		10.1.2022-9.30.2023 RENEW	7,000.00
186186	Summary				7,000.00
186187	PRO TITLE INC	220-7534-563.31-01	C21312	Junior mortgage policy	150.00
186187	Summary				150.00
186188	R A SMITH NATIONAL INC	502-2901-537.31-02	DNR005	August DNR005 Inspection	7,746.50
	R A SMITH NATIONAL INC	510-3803-536.75-01	MMSD10	August MMSD10 Inspection	8,945.50
186188	Summary				16,692.00
186189	REGISTRATION FEE TRUST	100-2101-521.70-02		title new squad	169.50
186189	Summary				169.50
186190	REINDERS INC	100-4301-533.44-08		Repair Parts	847.42
186190	Summary				847.42
186191	RELIANCE STANDARD LIFE INSURANCE CO	100-5217-517.21-11		LTD Oct premiums	5,484.95
186191	Summary				5,484.95
186192	RELIANT FIRE APPARATUS INC	100-2201-522.44-03		GASKET/POWER STEER PUMP	33.88
	RELIANT FIRE APPARATUS INC	100-2201-522.44-03		MISC PARTS/#4209	559.10
	RELIANT FIRE APPARATUS INC	100-2201-522.44-03		MISC PARTS/#4209/#4208	711.30
186192	Summary				1,304.28
186193	RHYME BUSINESS PRODUCTS LLC	100-1101-517.30-13		Rhyme - August	5,606.05
186193	Summary				5,606.05
186194	RITTER TECHNOLOGY LLC	100-2201-522.51-08		SHOP HOSE/FITTINGS	94.83
	RITTER TECHNOLOGY LLC	100-4218-531.44-08		Hose assembly (2)	132.50
	RITTER TECHNOLOGY LLC	100-4218-531.44-08		Brake hoses	462.84
	RITTER TECHNOLOGY LLC	100-4218-531.44-08		Repair Parts	27.29
186194	Summary				717.46
186195	ROAD & CONSTRUCTION MATERIALS	501-2707-537.44-56		CleanFill:SingleAxle Load	100.00
	ROAD & CONSTRUCTION MATERIALS	501-2708-537.44-57		CleanFill:SingleAxle Load	100.00
186195	Summary				200.00
186196	SCHWAAB INC	100-2201-522.60-01		(9) FIREFIGHTER BADGES	733.17
186196	Summary				733.17
186197	SEH DESIGN/BUILD INC	501-2706-537.44-54		Chgorder-plbgmodification	2,475.00
	SEH DESIGN/BUILD INC	501-2706-537.44-54		drain line vlv-chg order	3,825.00
186197	Summary				6,300.00
186198	SIDELLO PROPERTY SERVICES INC	100-2406-524.30-04	A11111	1830 S 57 St	335.00
	SIDELLO PROPERTY SERVICES INC	100-2406-524.30-31		Grass cutting	1,716.00
186198	Summary				2,051.00
186199	SOUTHTOWN TIRE & AUTO	100-2110-521.44-03		sqd 21 repairs	69.99
186199	Summary				69.99
186200	SPANISH JOURNAL	240-7936-542.51-09	EF2108	ADVERTISTING- VACCINATION	1,000.00
186200	Summary				1,000.00
186201	STARK PAVEMENT CORP	100-4218-531.53-02		3/8 surface	204.23
	STARK PAVEMENT CORP	501-2707-537.53-08		3/8 surface	562.46
	STARK PAVEMENT CORP	540-1801-538.53-02		3/8 surface	65.25
186201	Summary				831.94
186202	STATE OF WI- DSPS	100-0000-421.11-00		State Mobile Home Reimb	693.75
186202	Summary				693.75
186203	STATE OF WISCONSIN	100-0000-451.01-00		August Court Fines	19,906.81
186203	Summary				19,906.81
186204	STRYKER MEDICAL	100-2201-522.44-03		POWER LOAD BATTERY/#4414	641.87
186204	Summary				641.87
186205	SUPERION, LLC	100-1101-517.32-01		Naviline Inv-05 Oct 2022	12,611.00
186205	Summary				12,611.00
186206	SUPERIOR SIDING & WINDOWS INC	220-7534-563.31-01	C21315	Payment to contractor	7,660.00
186206	Summary				7,660.00
186207	SYMBIONT	501-2901-537.30-02		Lead Srvc Line Solution	4,836.00
186207	Summary				4,836.00
186208	T-MOBILE USA, INC.	255-8101-521.30-04	I22538	PEN/GPS 8431	415.00
	T-MOBILE USA, INC.	255-8101-521.30-04	I22538	PEN 1788	315.00

**Monthly Listing of Claims Paid
October 2022**

Check#	Vendor	GL Account	Proj No	Description	Amount
186208	T-MOBILE USA, INC.	255-8101-521.30-04	I22538	PEN 6828	315.00
186208 - Summary					1,045.00
186209	TAPCO	100-4118-531.44-07		Navigator EZ 2Wire Contro	2,640.00
186209 - Summary					2,640.00
186210	TRI CITY NATIONAL BANK	100-0000-229.04-00		Martin Bankruptcy	576.65
	TRI CITY NATIONAL BANK	100-0000-229.16-00		September Loan Payments	485.76
	TRI CITY NATIONAL BANK	220-7521-563.30-04	C22101	TCNB LOAN SERVICING FEES	55.00
	TRI CITY NATIONAL BANK	224-7701-563.30-04		TCNB LOAN SERVICING FEES	35.00
	TRI CITY NATIONAL BANK	396-6301-563.30-07		TCNB LOAN SERVICING FEES	5.00
	TRI CITY NATIONAL BANK	397-6301-563.30-07		TCNB LOAN SERVICING FEES	18.00
186210 - Summary					1,175.41
186211	TRUCK COUNTRY	100-4218-531.44-08		Crankcase breather hsing.	359.34
	TRUCK COUNTRY	100-4218-531.44-08		Repair Parts	36.13
	TRUCK COUNTRY	100-4218-531.44-08		Wrong Quantity	(180.65)
	TRUCK COUNTRY	100-4218-531.44-08		DEF valve-solenoid	479.12
186211 - Summary					693.94
186212	US POSTAL SERVICE(POSTAGE-BY-PHONE)	100-2101-521.51-01		refill postage Sept	1,500.00
186212 - Summary					1,500.00
186213	USI INSURANCE SERVICES, LLC	602-9101-517.30-02		Sept Invoice	5,416.66
	USI INSURANCE SERVICES, LLC	602-9101-517.30-02		Oct Invoice	5,416.66
	USI INSURANCE SERVICES, LLC	602-9101-517.30-02		Aug Invoice	5,416.66
186213 - Summary					16,249.98
186214	VAUGHAN, KATELYN	255-8101-521.56-03	I22534	EB Mtg MN	645.38
186214 - Summary					645.38
186215	VERIZON WIRELESS	100-1401-515.41-06		August Verizon	13,205.18
186215 - Summary					13,205.18
186216	VERIZON WIRELESS SERVICES	255-8101-521.30-04	I22538	PLU 3332	220.00
186216 - Summary					220.00
186217	VERMEER-WISCONSIN INC	100-4301-533.44-08		Misc. clutch parts	599.96
	VERMEER-WISCONSIN INC	100-4301-533.44-08		Repair Parts	59.78
	VERMEER-WISCONSIN INC	501-2901-537.44-08		Relay	11.07
186217 - Summary					670.81
186218	WE ENERGIES	354-6053-523.31-02	BF0027	Elec srvs Police gen	28,262.50
186218 - Summary					28,262.50
186219	WEDA	258-3102-565.56-02		WEDA - LX Sponsorship	1,500.00
186219 - Summary					1,500.00
186220	WEST MICHIGAN INVESTMENTS, LLC	255-8101-521.43-03	I21534	Rent	48,729.75
	WEST MICHIGAN INVESTMENTS, LLC	255-8101-521.43-03	I22534	Rent	46,083.45
186220 - Summary					94,813.20
186221	WI STATE LABORATORY OF HYGIENE	240-7908-542.53-41	H22009	LAB TESTS	90.00
186221 - Summary					90.00
186222	WINDSTREAM	255-8101-521.30-04	I22549	Internet	9,738.45
186222 - Summary					9,738.45
186223	YES EQUIPMENT & SERVICES INC	100-4118-531.44-08		Repair Parts	138.99
186223 - Summary					138.99
186224	ZIGNEGO READY MIX INC	501-2707-537.53-08		1.25 base course	387.01
	ZIGNEGO READY MIX INC	540-1801-538.53-02		1.25 base course	124.43
186224 - Summary					511.44
186225	ZORN COMPRESSOR & EQUIPMENT INC	100-2201-522.44-02		ST 63/COMPRESSOR	101.06
186225 - Summary					101.06
10/06/2022 - Summary					1,412,686.83

Payment Date: 10/10/2022

Check#	Vendor	GL Account	Proj No	Description	Amount
31031	US BANK - PCARD	100-0000-229.07-00		SAMS CLUB #8164	191.13
	US BANK - PCARD	100-0000-441.08-00		DOJ EPAY RECORDS CHECK	371.00
	US BANK - PCARD	100-0301-516.51-02		OFFICEMAX/DEPOT 6869	91.72
	US BANK - PCARD	100-0304-516.57-02		WWW.TABLEGROUP.COM	25.00
	US BANK - PCARD	100-0501-517.52-02		REALTOR ASSOCIATION/MLS	64.00

Monthly Listing of Claims Paid
October 2022

Check#	Vendor	GL Account	Proj No	Description	Amount
31031	US BANK - PCARD	100-0501-517.52-02		COSTAR GROUP INC	400.00
	US BANK - PCARD	100-0501-517.57-01		REALTOR ASSOCIATION/MLS	868.00
	US BANK - PCARD	100-1101-517.32-01		DROPBOX*6B52YH5Z8D84	125.00
	US BANK - PCARD	100-1101-517.32-01		DROPBOX*HFTDFW3VGDZ7	125.00
	US BANK - PCARD	100-1101-517.44-08		CDW GOVT #CX54610	251.24
	US BANK - PCARD	100-1101-517.44-08		AMZN MKTP US*1M8UE29T0	179.99
	US BANK - PCARD	100-1101-517.51-02		AMZN MKTP US	(19.23)
	US BANK - PCARD	100-1101-517.51-11		AMZN MKTP US*1F7N163N2	1,699.20
	US BANK - PCARD	100-1101-517.56-01		SQ *WEST ALLIS CHEESE & S	95.38
	US BANK - PCARD	100-1301-517.51-02		OFFICEMAX/DEPOT 6869	106.74
	US BANK - PCARD	100-1301-517.54-02		FACEBK *SYWM2HTRY2	50.00
	US BANK - PCARD	100-1301-517.54-02		LINKEDIN 7397548036	42.19
	US BANK - PCARD	100-1301-517.54-02		FACEBK *BGJ3EG7RY2	279.10
	US BANK - PCARD	100-1301-517.57-02		UW LOCAL GOV EDUCATION	4,400.00
	US BANK - PCARD	100-1401-515.51-02		OFFICEMAX/DEPOT 6869	27.07
	US BANK - PCARD	100-1502-514.51-02		AMZN MKTP US*1M3UY33F1	35.70
	US BANK - PCARD	100-1502-514.51-02		AMZN MKTP US*1U1S31NS1	31.64
	US BANK - PCARD	100-1502-514.51-02		AMZN MKTP US*1F7132ID0	7.99
	US BANK - PCARD	100-1502-514.51-02		THE HOME DEPOT #4902	324.50
	US BANK - PCARD	100-2101-521.30-04		SHRED-IT USA LLC	59.86
	US BANK - PCARD	100-2101-521.32-01		TDS METROCOM	335.93
	US BANK - PCARD	100-2101-521.44-01		AMAZON.COM*1F5867291	190.86
	US BANK - PCARD	100-2101-521.44-01		AMZ*AMAZON.COM	(190.86)
	US BANK - PCARD	100-2101-521.51-02		AMAZON.COM*926977LV3	51.84
	US BANK - PCARD	100-2101-521.51-02		AMZN MKTP US*1U99N1CG2	125.90
	US BANK - PCARD	100-2101-521.51-02		OFFICEMAX/DEPOT 6869	1,127.20
	US BANK - PCARD	100-2101-521.51-02		AMZN MKTP US*1U17E3CF0	284.00
	US BANK - PCARD	100-2101-521.51-02		AMZN MKTP US*1V2Y30XH1	308.50
	US BANK - PCARD	100-2101-521.51-09		AMAZON.COM*1U3MM8L00	40.42
	US BANK - PCARD	100-2107-521.51-05		KIESLER POLICE SUPPLY	2,105.00
	US BANK - PCARD	100-2107-521.53-41		N AMERICA RESCUE PRODUCT	186.12
	US BANK - PCARD	100-2107-521.57-02		FBI LEEDA INC	1,390.00
	US BANK - PCARD	100-2107-521.60-01		ALLIS BIKE & FITNESS	172.56
	US BANK - PCARD	100-2107-521.60-01		AMZN MKTP US*1F2SZ6N42	31.75
	US BANK - PCARD	100-2107-521.60-01		GUIDEFITTER, INC.	126.31
	US BANK - PCARD	100-2107-521.60-01		AMZN MKTP US*1M7QH7EM2	49.52
	US BANK - PCARD	100-2110-521.51-06		AMZN MKTP US	(61.88)
	US BANK - PCARD	100-2110-521.51-06		DO MY OWN	264.06
	US BANK - PCARD	100-2110-521.51-06		NASSCO INC.	116.38
	US BANK - PCARD	100-2110-521.51-06		ULINE *SHIP SUPPLIES	470.65
	US BANK - PCARD	100-2114-521.51-03		ULINE *SHIP SUPPLIES	51.28
	US BANK - PCARD	100-2201-522.44-01		KATHY'S SHADE SHOP	259.00
	US BANK - PCARD	100-2201-522.44-03		AMZN MKTP US*7T22T2FJ3	139.26
	US BANK - PCARD	100-2201-522.44-03		VELVAC	439.05
	US BANK - PCARD	100-2201-522.44-08		AMZN MKTP US*1V4YD89M2	16.80
	US BANK - PCARD	100-2201-522.44-08		PARTS USA	33.14
	US BANK - PCARD	100-2201-522.51-02		OFFICEMAX/DEPOT 6869	78.63
	US BANK - PCARD	100-2201-522.51-04		NASSCO INC.	202.28
	US BANK - PCARD	100-2201-522.51-04		STARBUCKS 800-782-7282	4.78
	US BANK - PCARD	100-2201-522.51-04		SQ *AGGIE'S BAKERY & CAKE	24.00
	US BANK - PCARD	100-2201-522.51-04		AMAZON.COM*1M96J0C50	61.99
	US BANK - PCARD	100-2201-522.51-06		GRAINGER	181.26
	US BANK - PCARD	100-2201-522.51-06		NASSCO INC.	782.77
	US BANK - PCARD	100-2201-522.51-08		XBC FLOW SERVICES - WISC	99.00
	US BANK - PCARD	100-2201-522.51-08		HARBOR FREIGHT TOOLS 280	60.46
	US BANK - PCARD	100-2201-522.51-08		QUALITY CALIBRATION SERVI	166.40
	US BANK - PCARD	100-2201-522.51-09		O'REILLY AUTO PARTS 3273	43.09
	US BANK - PCARD	100-2201-522.52-01		MILWAUKEE JOURNAL	14.99
	US BANK - PCARD	100-2201-522.53-27		THE UPS STORE 6257	36.87
	US BANK - PCARD	100-2201-522.53-27		AMZN MKTP US*1F7Y85RH1	204.05
	US BANK - PCARD	100-2201-522.53-27		ULINE *SHIP SUPPLIES	348.70
	US BANK - PCARD	100-2201-522.53-27		AMZN MKTP US*1V8B769K2	35.00
	US BANK - PCARD	100-2201-522.54-02		OTC BRANDS INC	74.45
	US BANK - PCARD	100-2201-522.54-02		POSITIVE PROMOTIONS	2,207.70
	US BANK - PCARD	100-2201-522.56-02		RESIDENCE INN MARRIOTT	823.77

Monthly Listing of Claims Paid
October 2022

Check#	Vendor	GL Account	Proj No	Description	Amount
31031	US BANK - PCARD	100-2201-522.56-02		UNITED 0162434123716	798.20
	US BANK - PCARD	100-2201-522.56-02		ORBITZ*72384240051496	236.97
	US BANK - PCARD	100-2201-522.57-01		AMERICAN HEART SHOPCPR	17.00
	US BANK - PCARD	100-2201-522.57-02		CENTER FOR PUBLIC SAFETY	650.00
	US BANK - PCARD	100-2301-523.57-01		AMERICAN PLANNING A	99.00
	US BANK - PCARD	100-2401-524.51-02		AMZN MKTP US*L167A1RU3	27.17
	US BANK - PCARD	100-2401-524.51-02		AMZN MKTP US*1M2178H20	43.18
	US BANK - PCARD	100-2501-515.57-02		LOCAL GOVERNMENT EDUCATIO	(274.00)
	US BANK - PCARD	100-3001-541.51-02		AMZN MKTP US*3960X1663	10.03
	US BANK - PCARD	100-3001-541.51-02		AMAZON.COM*1M3YK7OQ1 AMZN	11.20
	US BANK - PCARD	100-3001-541.51-02		AMZN MKTP US*1F93Q8JU2	19.98
	US BANK - PCARD	100-3001-541.51-02		AMZN MKTP US*1M7022RZ1	22.11
	US BANK - PCARD	100-3001-541.51-02		AMZN MKTP US*1F2GO5EA2	29.95
	US BANK - PCARD	100-3001-541.51-02		WALMART.COM AA	55.89
	US BANK - PCARD	100-3001-541.51-02		OFFICEMAX/DEPOT 6869	15.06
	US BANK - PCARD	100-3001-541.51-02		AMZN MKTP US*1M4FF92M0	6.32
	US BANK - PCARD	100-3001-541.51-06		AMZN MKTP US*1F2GO5EA2	124.24
	US BANK - PCARD	100-3001-541.51-06		AMZN MKTP US	(5.99)
	US BANK - PCARD	100-3001-541.51-09		AMZN MKTP US*T87018MA3	82.89
	US BANK - PCARD	100-3001-541.56-02		THE RIDGE - LODGING	192.00
	US BANK - PCARD	100-3001-541.57-02		PAYPAL *WEHA WEHA	300.00
	US BANK - PCARD	100-3003-541.53-41		WM SUPERCENTER #1635	(5.22)
	US BANK - PCARD	100-3003-541.53-41		AMZN MKTP US*1F2GO5EA2	35.96
	US BANK - PCARD	100-3004-541.57-02		PAYPAL *WEHA WEHA	300.00
	US BANK - PCARD	100-3004-541.57-02		SARANIECKI INSTITUTE	499.00
	US BANK - PCARD	100-3101-565.57-02		WI DEPARTMENT OF AGRICULT	55.00
	US BANK - PCARD	100-3401-544.51-02		AMZN MKTP US*1U78A3ZH0	13.98
	US BANK - PCARD	100-3401-544.51-02		AMZN MKTP US*1U0MV2TM1	55.16
	US BANK - PCARD	100-3401-544.51-06		AMZN MKTP US*VN85P3AF3	42.52
	US BANK - PCARD	100-3401-544.51-06		AMZN MKTP US*1V37R5E01	121.56
	US BANK - PCARD	100-3501-555.32-01		DNH*GODADDY.COM	62.32
	US BANK - PCARD	100-3501-555.51-01		USPS PO 5687650214	49.76
	US BANK - PCARD	100-3501-555.51-02		AMZN MKTP US*1V8HI08W2	68.50
	US BANK - PCARD	100-3501-555.51-02		OFFICEMAX/DEPOT 6869	139.88
	US BANK - PCARD	100-3501-555.51-02		AMAZON.COM*1F6TK11J1 AMZN	193.31
	US BANK - PCARD	100-3501-555.70-01		IN *AUNT FLOW, LLC	280.00
	US BANK - PCARD	100-3502-555.52-21		BAKER & TAYLOR - BOOKS	130.06
	US BANK - PCARD	100-3502-555.52-23		BAKER & TAYLOR - BOOKS	27.27
	US BANK - PCARD	100-3502-555.52-28		AMZN MKTP US*1F9T66YV0	12.22
	US BANK - PCARD	100-3502-555.52-28		AMZN MKTP US*1M2W72OG2	17.99
	US BANK - PCARD	100-3502-555.52-28		BAKER & TAYLOR - BOOKS	2,707.93
	US BANK - PCARD	100-3502-555.52-28		AMAZON.COM*1M0218HR1 AMZN	15.99
	US BANK - PCARD	100-3502-555.52-30		BAKER & TAYLOR - BOOKS	189.61
	US BANK - PCARD	100-3502-555.52-31		HEARST MEMBERSHIP	40.00
	US BANK - PCARD	100-3502-555.52-31		D J*WALL-ST-JOURNAL	609.78
	US BANK - PCARD	100-3502-555.52-33		GREY HOUSE PUBLISHING SAL	295.70
	US BANK - PCARD	100-3502-555.52-36		CAMPAIGNMONITOR	24.65
	US BANK - PCARD	100-3502-555.52-38		BAKER & TAYLOR - BOOKS	912.69
	US BANK - PCARD	100-3502-555.52-40		BAKER & TAYLOR - BOOKS	49.07
	US BANK - PCARD	100-3502-555.52-45		BAKER & TAYLOR - BOOKS	8.61
	US BANK - PCARD	100-3502-555.52-48		BAKER & TAYLOR - BOOKS	3,363.53
	US BANK - PCARD	100-3502-555.52-57		BAKER & TAYLOR - BOOKS	122.25
	US BANK - PCARD	100-3504-555.51-02		BRODART SUPPLIES	162.10
	US BANK - PCARD	100-3506-555.51-09		AMZN MKTP US*1F57D7372	19.47
	US BANK - PCARD	100-3506-555.51-09		AMZN MKTP US*1F3C95VT1	8.99
	US BANK - PCARD	100-3506-555.51-09		DOLLAR TREE	2.64
	US BANK - PCARD	100-3506-555.51-09		DOLLAR TREE, INC.	31.65
	US BANK - PCARD	100-3506-555.51-09		SSL ECOMM	16.66
	US BANK - PCARD	100-3506-555.51-09		SP LETSTICKTOGETHER	44.35
	US BANK - PCARD	100-3506-555.51-09		AMZN MKTP US*1M2W72OG2	94.12
	US BANK - PCARD	100-3506-555.51-09		PICK N SAVE #847	65.14
	US BANK - PCARD	100-3506-555.51-09		AMZN MKTP US*UE5OD4M93	24.99
	US BANK - PCARD	100-3507-555.51-06		UNGERCLEANING.COM	13.19
	US BANK - PCARD	100-3507-555.51-06		NASSCO INC.	548.19
	US BANK - PCARD	100-4001-533.51-01		UPS*1ZE703Y90392461988	20.42

Monthly Listing of Claims Paid
October 2022

Check#	Vendor	GL Account	Proj No	Description	Amount
31031	US BANK - PCARD	100-4001-533.51-02		OFFICEMAX/DEPOT 6869	41.38
	US BANK - PCARD	100-4001-533.51-09		DOLLAR TREE	2.50
	US BANK - PCARD	100-4101-533.44-08		FERGUSON ENT #1020	277.85
	US BANK - PCARD	100-4101-533.44-08		THE HOME DEPOT #4902	38.70
	US BANK - PCARD	100-4101-533.44-08		HAJOCA ABLE DIST 353	520.06
	US BANK - PCARD	100-4101-533.44-08		SHERWIN WILLIAMS 703713	31.19
	US BANK - PCARD	100-4101-533.44-08		ELLIOTT ACE HDWE	91.01
	US BANK - PCARD	100-4101-533.44-08		SHERWIN WILLIAMS 704324	78.59
	US BANK - PCARD	100-4101-533.44-08		MARK'S PLUMBING PARTS	883.06
	US BANK - PCARD	100-4101-533.44-08		MENARDS WEST ALLIS WI	21.96
	US BANK - PCARD	100-4101-533.53-02		THE HOME DEPOT #4902	46.35
	US BANK - PCARD	100-4101-533.53-02		FERGUSON ENT #1020	754.00
	US BANK - PCARD	100-4101-533.53-02		SHERWIN WILLIAMS 703713	135.98
	US BANK - PCARD	100-4101-533.53-02		MENARDS WEST ALLIS WI	490.18
	US BANK - PCARD	100-4101-533.53-02		MENARDS WEST MILWAUKEE WI	23.52
	US BANK - PCARD	100-4101-533.53-02		SP V-BELT GUYS	13.03
	US BANK - PCARD	100-4101-533.60-02		MENARDS WEST ALLIS WI	7.74
	US BANK - PCARD	100-4201-535.30-04		DNR WS2 EM1 EPAY DEM SALE	704.00
	US BANK - PCARD	100-4201-535.30-04		DNR WS2 EM1 EPAY DEM SRVF	14.08
	US BANK - PCARD	100-4201-535.51-02		WHITLOWS SECURITY SPECIAL	19.96
	US BANK - PCARD	100-4201-535.51-02		AMZN MKTP US*1F07J9UN2	89.95
	US BANK - PCARD	100-4218-531.44-08		UPS*1Z105T6V0300018415	43.65
	US BANK - PCARD	100-4218-531.51-02		OFFICEMAX/DEPOT 6175	79.84
	US BANK - PCARD	100-4218-531.51-02		AMZN MKTP US*1M5EN5IB2	38.38
	US BANK - PCARD	100-4218-531.51-02		AMZN MKTP US*1U26C5FZ1	17.25
	US BANK - PCARD	100-4218-531.57-02		UWCC REGISTRATIONS	1,095.00
	US BANK - PCARD	100-4218-531.57-02		APWA - NATIONAL	300.00
	US BANK - PCARD	100-4301-533.51-09		MENARDS WEST ALLIS WI	32.97
	US BANK - PCARD	100-4301-533.51-09		MENARDS WEST MILWAUKEE WI	83.16
	US BANK - PCARD	100-4301-533.51-09		REINDERS WAUKESHA	105.00
	US BANK - PCARD	100-4301-533.51-09		TREESTUFF	115.98
	US BANK - PCARD	100-4301-533.51-09		IN *CON-COR COMPANY, INC.	15.80
	US BANK - PCARD	100-4301-533.51-09		UW EXTENSION	65.00
	US BANK - PCARD	100-4301-533.53-02		MENARDS WEST MILWAUKEE WI	134.77
	US BANK - PCARD	100-4301-533.53-02		THE HOME DEPOT #4902	125.64
	US BANK - PCARD	100-4301-533.53-02		LEMKE STONE QUARRY A	657.20
	US BANK - PCARD	100-4301-533.53-02		LIESENER SOILS	1,560.00
	US BANK - PCARD	100-4401-533.51-02		AMZN MKTP US*1M2D645B1	22.99
	US BANK - PCARD	100-4401-533.64-03		UPS*BILLING CENTER	15.99
	US BANK - PCARD	100-4501-533.52-01		CUMMINS OSM	770.00
	US BANK - PCARD	100-4601-533.51-02		AMZN MKTP US*4W23W5YT3	17.98
	US BANK - PCARD	100-5002-517.51-09		AWARDS REC	292.41
	US BANK - PCARD	100-5007-552.51-09		AMZN MKTP US*WA40D1AV3 AM	248.99
	US BANK - PCARD	100-5007-552.51-09		4IMPRINT, INC	243.58
	US BANK - PCARD	100-5007-552.51-09		AMAZON.COM*1V9RH6XQ2	42.04
	US BANK - PCARD	100-5007-552.51-09		AMZN MKTP US*1F4Q64PA1	139.61
	US BANK - PCARD	100-8813-517.30-04		ZOOM.US 888-799-9666	199.90
	US BANK - PCARD	201-5101-517.32-01		DNH*GODADDY.COM	519.25
	US BANK - PCARD	201-5101-517.54-03		QUAD GRAPHICS INC	1,850.00
	US BANK - PCARD	207-0612-544.51-09		PICK N SAVE #847	69.08
	US BANK - PCARD	207-0612-544.51-09		GFS STORE #1929	152.22
	US BANK - PCARD	207-0613-544.51-09		PICK N SAVE #847	103.97
	US BANK - PCARD	207-0613-544.51-09		AMZN MKTP US*1U8IX4XA1	799.00
	US BANK - PCARD	207-0613-544.51-09		WAL-MART #5669	63.88
	US BANK - PCARD	207-0613-544.51-09		GFS STORE #1929	99.93
	US BANK - PCARD	207-0615-544.51-09		AMZN MKTP US*1M35W3IL2	21.95
	US BANK - PCARD	212-0801-521.64-05		WAL-MART #5438	12.40
	US BANK - PCARD	212-0801-521.64-05		AMZN MKTP US*1F5FZ9NJ1	78.92
	US BANK - PCARD	214-0801-521.64-05		HYATT REGENCY GREEN BAY	572.88
	US BANK - PCARD	214-0801-521.64-05		SIRCHIE FINGER PRINT LABO	2,113.25
	US BANK - PCARD	215-0801-521.64-05		TST* CAPRI DI NUOVO	166.18
	US BANK - PCARD	215-0801-521.64-05		MARRIOTT MADISON WEST	706.07
	US BANK - PCARD	215-0801-521.64-05		PICK N SAVE #846	6.98
	US BANK - PCARD	215-0801-521.64-05		RAYALLEN.COM JJDOG.COM	450.44
	US BANK - PCARD	215-0801-521.64-05		ELITE K9 INC 2	370.22

Monthly Listing of Claims Paid
October 2022

Check#	Vendor	GL Account	Proj No	Description	Amount
31031	US BANK - PCARD	215-0801-521.64-05		PAYPAL *WLECHA	70.00
	US BANK - PCARD	215-0801-521.64-05		PACKTRACK	140.00
	US BANK - PCARD	215-0801-521.64-05		AMAZON.COM*1F0R84HX1 AMZN	349.85
	US BANK - PCARD	215-0801-521.64-05		FESTIVAL FOODS WEST	61.71
	US BANK - PCARD	217-0901-522.64-05	FR0005	AMZN MKTP US*1F9D976A2	149.00
	US BANK - PCARD	217-0901-522.64-05	FR0005	AED SUPERSTORE	4,470.00
	US BANK - PCARD	217-0901-522.64-05	FR0005	AMZN MKTP US*1M9M27ES1	229.95
	US BANK - PCARD	220-7522-563.51-09	C22218	AMZN MKTP US*1M8Z57N51	14.59
	US BANK - PCARD	220-7522-563.51-09	C22218	AMZN MKTP US*1F3AW4000	9.49
	US BANK - PCARD	220-7522-563.51-09	C22218	WAL-MART #5438	54.60
	US BANK - PCARD	220-7522-563.51-09	C22218	AMZN MKTP US*1M7Y71341	85.32
	US BANK - PCARD	220-7522-563.51-09	C22218	AMZN MKTP US*1F2VW58X0	7.91
	US BANK - PCARD	220-7522-563.51-09	C22218	ZOOM.US 888-799-9666	14.99
	US BANK - PCARD	222-7601-563.30-04		DOJ EPAY RECORDS CHECK	35.00
	US BANK - PCARD	222-7601-563.56-02		LAKELAWN RESORT ROOMS	497.94
	US BANK - PCARD	222-7601-563.70-01		AMZN MKTP US*1M0AA8MG0	127.19
	US BANK - PCARD	240-7904-542.31-02	H22047	FBL*FRESHBABY	721.15
	US BANK - PCARD	240-7904-542.51-01	H22047	USPS.COM CLICKNSHIP	5.10
	US BANK - PCARD	240-7911-542.31-02	H22012	SIGNUPGENIUS	29.99
	US BANK - PCARD	240-7936-542.51-09	EF2108	FACEBK *HVGCCF3H32	35.00
	US BANK - PCARD	240-7936-542.51-09	EF2108	FACEBK *T376UGFH32	35.00
	US BANK - PCARD	240-7939-542.57-01	EF2107	UW LOCAL GOV EDUCATION	4,400.00
	US BANK - PCARD	255-8101-521.30-04	I22534	STAMPS.COM	17.99
	US BANK - PCARD	255-8101-521.30-04	I22549	AMAZON WEB SERVICES	11.71
	US BANK - PCARD	255-8101-521.51-09	I22534	OFFICEMAX/DEPOT 6869	24.43
	US BANK - PCARD	255-8101-521.51-09	I22538	OFFICEMAX/DEPOT 6869	55.89
	US BANK - PCARD	255-8101-521.51-09	I22556	OFFICEMAX/DEPOT 6869	158.33
	US BANK - PCARD	257-5701-517.51-09	SPCITY	PARTY CITY 5141	58.10
	US BANK - PCARD	257-5701-517.51-09	SPCITY	PICK N SAVE #847	133.09
	US BANK - PCARD	257-5701-517.51-09	SPCITY	AMZN MKTP US*1M6MK1CO2 AM	202.54
	US BANK - PCARD	257-5701-517.51-09	SP0007	CUSTOMINK LLC	505.86
	US BANK - PCARD	257-5701-517.51-09	SP0007	AMZN MKTP US*1M44O4QZ0	42.40
	US BANK - PCARD	257-5701-517.51-09	SP0007	B&H PHOTO 800-606-6969	29.54
	US BANK - PCARD	257-5701-517.51-09	SP0007	DAVE'S PRODUCE	37.09
	US BANK - PCARD	258-3102-565.51-04		MIS SUENOS	74.85
	US BANK - PCARD	258-3102-565.51-04		WALGREENS #10963	47.11
	US BANK - PCARD	258-3102-565.51-04		GREBE S BAKERY	31.15
	US BANK - PCARD	258-3102-565.56-02		PAYPAL *MILENILINKM	250.00
	US BANK - PCARD	258-3102-565.57-01		EB 2022 URBAN SPACESH	64.98
	US BANK - PCARD	258-3102-565.57-02		WEDA	178.00
	US BANK - PCARD	258-3102-565.57-02		WI DFI WS2 PCC CC EPAY	27.00
	US BANK - PCARD	260-8201-517.30-04		BUNNY STUDIO BUNNY STU	487.00
	US BANK - PCARD	260-8201-517.32-01		SPROUT SOCIAL, INC	323.00
	US BANK - PCARD	260-8201-517.54-03		FACEBK *BGJ3EG7RY2	247.59
	US BANK - PCARD	260-8201-517.54-03		FACEBK *SYWM2HTRY2	550.00
	US BANK - PCARD	260-8201-517.54-03		FACEBK *CXLMJJ79Z2	60.00
	US BANK - PCARD	260-8202-517.32-01		LUMEN5.COM	79.00
	US BANK - PCARD	260-8202-517.32-01		GRAMMARLY CO5YE3LMG	79.20
	US BANK - PCARD	260-8202-517.32-01		RISEVISION	31.50
	US BANK - PCARD	260-8202-517.32-01		STK*SHUTTERSTOCK	209.95
	US BANK - PCARD	260-8202-517.32-01		MAILCHIMP	97.99
	US BANK - PCARD	260-8202-517.32-01		ADOBE ACROPRO SUBS	222.55
	US BANK - PCARD	260-8202-517.32-04		PB LEASING	704.79
	US BANK - PCARD	260-8202-517.51-02		WESTERN STATES ENVELOPE	2,201.50
	US BANK - PCARD	260-8202-517.51-02		PITNEY BOWES PI	531.18
	US BANK - PCARD	260-8202-517.51-02		AMZN MKTP US*1U09J8ZM2	126.71
	US BANK - PCARD	260-8202-517.51-02		AMZN MKTP US*1U07X20P0	157.62
	US BANK - PCARD	260-8202-517.51-02		BLANKS/USA	465.79
	US BANK - PCARD	260-8202-517.51-09		GAN*NEWSPAPERSUBSCRIPT	7.99
	US BANK - PCARD	263-5001-517.51-09		MARCOS PIZZA - 3516	48.22
	US BANK - PCARD	266-8350-522.53-41		4IMPRINT, INC	431.94
	US BANK - PCARD	397-6307-563.31-67		AMZN MKTP US*8L5GG3W23	25.49
	US BANK - PCARD	501-2601-537.51-01		USPS PO 5672200227	12.64
	US BANK - PCARD	501-2602-537.44-51		SYLVANE	3,666.85
	US BANK - PCARD	501-2707-537.51-09		WEST ALLIS FULL SERVICE C	40.00

Monthly Listing of Claims Paid
October 2022

Check#	Vendor	GL Account	Proj No	Description	Amount
31031	US BANK - PCARD	501-2708-537.44-57		THE HOME DEPOT #4902	17.34
	US BANK - PCARD	501-2709-537.44-59		FERGUSON ENT #1020	301.87
	US BANK - PCARD	501-2709-537.44-59		GENERAL FIRE EQUIP.	286.00
	US BANK - PCARD	501-2709-537.44-59		HAJOCA ABLE DIST 353	87.54
	US BANK - PCARD	501-2709-537.44-59		DSPS EPAY ISE	80.00
	US BANK - PCARD	501-2709-537.44-59		DSPS E SERVICE FEE COM	1.60
	US BANK - PCARD	501-2709-537.71-05		MARK'S PLUMBING PARTS	1,579.80
	US BANK - PCARD	501-2710-537.44-60		POLLARDWATER.COM #3326	76.00
	US BANK - PCARD	501-2710-537.44-60		THE HOME DEPOT #4902	42.48
	US BANK - PCARD	501-2710-537.44-60		AMZN MKTP US*1M1FR8C90	47.00
	US BANK - PCARD	501-2802-537.32-01		TIMETAP	39.95
	US BANK - PCARD	501-2901-537.51-08		NORTHERN TOOL EQUIP	318.97
	US BANK - PCARD	501-2901-537.51-08		THE HOME DEPOT #4902	21.91
	US BANK - PCARD	501-2901-537.51-08		AMZN MKTP US*OJ2N14IV3	89.95
	US BANK - PCARD	501-2901-537.51-08		AMZN MKTP US*1V8MF1GW1	63.99
	US BANK - PCARD	501-2901-537.56-02		MONONA TERRACE	32.00
	US BANK - PCARD	501-2901-537.56-02		DOUBLETREE HOTELS	168.78
	US BANK - PCARD	501-2901-537.57-01		AWWA.ORG	319.20
	US BANK - PCARD	501-2901-537.57-02		EVENT* 2022 CUSTOMER P	500.00
	US BANK - PCARD	501-2901-537.58-01		DNR WS2 EM1 EPAY DEM SALE	45.00
	US BANK - PCARD	501-2901-537.58-01		DNR WS2 EM1 EPAY DEM SRVF	0.90
	US BANK - PCARD	510-3801-536.44-08		EBAY O*18-09123-72989	89.00
	US BANK - PCARD	510-3801-536.44-08		EBAY O*22-09122-35410	215.99
	US BANK - PCARD	540-1801-538.41-09		WASTE MGMT WM EZPAY	4,809.93
	US BANK - PCARD	550-4233-535.41-09		WASTE MGMT WM EZPAY	74,797.04
	US BANK - PCARD	550-4233-535.51-09		STRIPE TERMINAL	(136.00)
	US BANK - PCARD	550-4233-535.51-09		AMZN MKTP US*MA0FW6TE3	25.59
	US BANK - PCARD	550-4233-535.51-09		AMZN MKTP US	(24.98)
31031 - Summary					164,401.42
10/10/2022 - Summary					164,401.42

Payment Date: 10/18/2022

Check#	Vendor	GL Account	Proj No	Description	Amount
31017	BELOIT ROAD SENIOR APARTMENTS LLC	223-7602-563.43-07		HAPRENT-10-22	559.00
31017 - Summary					559.00
31018	BURNHAM HILL APTS	226-7605-563.43-08		HAPRENT-10-22	1,245.00
31018 - Summary					1,245.00
31019	FLESSAS, JOHN	223-7602-563.43-03		HAPRENT-10-22	426.00
31019 - Summary					426.00
31020	HEARTLAND-WEST ALLIS COURTYARD LLC	223-7602-563.43-03		HAPRENT-10-22	882.00
	HEARTLAND-WEST ALLIS COURTYARD LLC	226-7605-563.43-08		HAPRENT-10-22	218.00
31020 - Summary					1,100.00
31021	KLEIN, CAROL J	223-7602-563.43-03		HAPRENT-10-22	656.00
31021 - Summary					656.00
31022	LANDMARK HARMONY HOUSING LLC	223-7602-563.43-03		HAPRENT-10-22	2,604.00
	LANDMARK HARMONY HOUSING LLC	226-7605-563.43-08		HAPRENT-10-22	1,259.00
31022 - Summary					3,863.00
31023	LINCOLN CREST APARTMENTS	223-7602-563.43-03		HAPRENT-10-22	973.00
31023 - Summary					973.00
31024	METROPOLITAN ASSOCIATES	226-7605-563.43-08		HAPRENT-10-22	2,049.00
31024 - Summary					2,049.00
31025	MORRISON, TOM	226-7605-563.43-08		HAPRENT-10-22	80.00
31025 - Summary					80.00
31026	PORCH LIGHT PROPERTY MGMT	223-7602-563.43-03		HAPRENT-10-22	1,050.00
31026 - Summary					1,050.00
31027	SC RESIDENCE, LLC	226-7605-563.43-08		HAPRENT-10-22	462.00
31027 - Summary					462.00
31028	THE BERKSHIRE-WEST ALLIS	223-7602-563.43-03		HAPRENT-10-22	661.00
	THE BERKSHIRE-WEST ALLIS	226-7605-563.43-08		HAPRENT-10-22	620.00
31028 - Summary					1,281.00
31029	WE ENERGIES	223-7602-563.43-04		URRENT-10-22	32.00

Monthly Listing of Claims Paid
October 2022

Check#	Vendor	GL Account	Proj No	Description	Amount
31029	WE ENERGIES	226-7605-563.43-04		URRENT-10-22	55.00
31029 - Summary					87.00
10/18/2022 - Summary					13,831.00

Payment Date: 10/21/2022

Check#	Vendor	GL Account	Proj No	Description	Amount
31031	COREY OIL LTD	100-0000-141.01-00		PO NUM 144791	7,039.25
31031 - Summary					7,039.25
31032	FUEL SYSTEMS INC	100-0000-141.01-00		PO NUM 144797	868.24
31032 - Summary					868.24
31033	GRAINGER	100-0000-141.01-00		PO NUM 144798	459.89
31033 - Summary					459.89
31034	HUMPHREY SERVICE PARTS INC	100-0000-141.01-00		PO NUM 144800	267.82
31034 - Summary					267.82
31035	LOCAL 342 - CONDUIT FUND	100-0000-202.08-00		PAYROLL SUMMARY	440.00
31035 - Summary					440.00
31036	AB DATA	501-2802-537.51-01		Inserts to Water Bills	157.93
	AB DATA	501-2802-537.51-01		WATER UTILITY STATEMENTS	295.20
	AB DATA	510-3803-536.51-01		WATER UTILITY STATEMENTS	295.20
	AB DATA	540-1807-538.51-01		WATER UTILITY STATEMENTS	295.20
	AB DATA	550-4233-535.51-01		WATER UTILITY STATEMENTS	295.19
31036 - Summary					1,338.72
31037	ALFT, LYLE	100-5212-517.30-04		DPW Safety Shoe Reimb.	119.99
31037 - Summary					119.99
31038	ARING EQUIPMENT COMPANY INC	100-4218-531.44-08		Repair Parts	178.30
31038 - Summary					178.30
31039	BOSWEIN, SCOTT	100-1101-517.56-02		Boswein ProPhoenix Conf	412.50
31039 - Summary					412.50
31040	CIVICPLUS	100-3501-555.32-01		CIVIC+Subsite Annual Fees	1,302.33
31040 - Summary					1,302.33
31041	COFFIELD, CARSON	258-3102-565.56-02		WEDA La Crosse Conference	256.25
31041 - Summary					256.25
31042	COREY OIL LTD	100-2201-522.53-01		DIESEL EXHAUST FUEL	207.95
31042 - Summary					207.95
31043	FELDHUSEN, PETER	100-3004-541.56-01		August- Sep 2022	98.13
31043 - Summary					98.13
31044	GRAINGER	100-4101-533.53-02		dpw shed, Inchrn filters	79.20
	GRAINGER	540-1801-538.53-02		Chemical absorb sock	197.40
31044 - Summary					276.60
31045	HENG, GARRETT	255-8101-521.56-03	I22538	Sept 22	300.00
31045 - Summary					300.00
31046	HER, SUE	255-8101-521.56-03	I22538	Sept 22	30.00
31046 - Summary					30.00
31047	HOFFMAN, JAMES	255-8101-521.56-03	I22538	Sept 22	81.25
31047 - Summary					81.25
31048	HUMPHREY SERVICE PARTS INC	100-2201-522.44-03		(2) HUB CAPS/#4415	111.02
	HUMPHREY SERVICE PARTS INC	501-2901-537.44-03		(2) Q R Valve	68.09
	HUMPHREY SERVICE PARTS INC	540-1801-538.44-08		Wrong Mount Hole Pattern	(84.06)
	HUMPHREY SERVICE PARTS INC	540-1801-538.44-08		(4) Brass nipple	5.45
	HUMPHREY SERVICE PARTS INC	540-1801-538.44-08		Repair Parts	82.38
31048 - Summary					182.88
31049	INDUSTRIAL MARKETING	100-4218-531.44-08		Warning switch	204.93
31049 - Summary					204.93
31050	IWEN, JAMES	255-8101-521.56-03	I22538	Aug 22	55.00
	IWEN, JAMES	255-8101-521.56-03	I22538	June 22	102.96
	IWEN, JAMES	255-8101-521.56-03	I22538	July 22	55.00
	IWEN, JAMES	255-8101-521.56-03	I22538	Sept 22	165.00
	IWEN, JAMES	255-8101-521.56-03	I22538	October 22 mileage	55.00

**Monthly Listing of Claims Paid
October 2022**

Check#	Vendor	GL Account	Proj No	Description	Amount
31050 - Summary					432.96
31051	KINGSBURY, MATTHEW	100-5212-517.30-04		DPW Safety Shoe Reimb.	150.00
31051 - Summary					150.00
31052	LAST, TIMOTHY	100-5212-517.30-04		DPW Safety Shoe Reimb.	116.21
31052 - Summary					116.21
31053	LEUNG, FRANK	100-4601-533.14-10		Sept Mileage	95.63
31053 - Summary					95.63
31054	LINCOLN CONTRACTORS SUPPLY INC	100-4218-531.44-08		Misc. parts	73.11
31054 - Summary					73.11
31055	LITWAITIS, BECKY	240-7904-542.56-02	H22004	ORLANDO CONFERENCE	773.24
31055 - Summary					773.24
31056	MANIACI, NICOLO	100-3002-541.56-01		Mileage- September 2022	143.13
31056 - Summary					143.13
31057	NOVAK, KYLE	266-8350-522.56-03		MEAL REIMBURSEMENT	262.00
31057 - Summary					262.00
31058	PALEN, TIMOTHY	100-1101-517.56-02		Palen ProPhoenix Conf	448.72
31058 - Summary					448.72
31059	POOLER, MASON	266-8350-522.56-03		HOTEL/POOLER/SCHAAK	1,669.90
	POOLER, MASON	266-8350-522.56-03		UBER	45.44
	POOLER, MASON	266-8350-522.56-03		AIRFARE/POOLER/SCHAAK	1,536.40
	POOLER, MASON	266-8350-522.56-03		MEAL REIMBURSEMENT	298.00
31059 - Summary					3,549.74
31060	RODER, ZACHARY	100-2301-523.30-04		Pallas Days Inn - CSM Rec	30.00
31060 - Summary					30.00
31061	SANFILIPPO, JAMES	255-8101-521.51-09	I22534	Oven	269.99
31061 - Summary					269.99
31062	SCHAAK, JASON	266-8350-522.56-03		MEAL REIMBURSEMENT/SCHAAK	560.00
31062 - Summary					560.00
31063	SCHAER, STEVE	100-2301-523.51-04		Brown County Mtg Lunch	135.47
31063 - Summary					135.47
31064	SCHLOSS, PATRICK	258-3102-565.56-02		WEDC-La Crosse conference	374.88
31064 - Summary					374.88
31065	SHERWIN INDUSTRIES INC	100-4101-533.44-08		Repair Parts	105.50
	SHERWIN INDUSTRIES INC	100-4218-531.53-02		S5 Sand Hot Mix	135.00
	SHERWIN INDUSTRIES INC	100-4218-531.53-02		Road Repair Material	3,177.46
	SHERWIN INDUSTRIES INC	510-3801-536.53-02		Road Repair Material	1,519.88
31065 - Summary					4,937.84
31066	THOMAS, MELISSA	100-3003-541.56-01		CHS July-October 2022	48.75
31066 - Summary					48.75
31067	UNITED STATES POSTAL SERVICE	100-5002-517.51-01		Postage for Newsletter	6,181.60
31067 - Summary					6,181.60
31068	WE ENERGIES	100-2201-522.41-04		2040 S 67 Elec	1,991.94
	WE ENERGIES	100-2201-522.41-05		2040 S 67 St	331.86
	WE ENERGIES	100-4101-533.41-04		DPW Group Bill	4,160.52
	WE ENERGIES	100-4101-533.41-04		6300 W McGeoch	54.38
	WE ENERGIES	100-4101-533.41-04		Klentz Park	57.34
	WE ENERGIES	100-4101-533.41-05		6200 W Beloit Rd	9.90
	WE ENERGIES	100-4101-533.41-05		6300 W McGeoch	467.00
	WE ENERGIES	100-4118-531.41-04		Group Bill	4,142.81
	WE ENERGIES	100-4118-531.41-04		Lighting Group Bill	24,609.60
	WE ENERGIES	100-4118-531.41-04		Group Bill Elect	6,025.49
	WE ENERGIES	100-4118-531.41-04		2307 S 92 St Elec	16.25
	WE ENERGIES	100-4118-531.41-04		57th and Mineral Elec	166.81
	WE ENERGIES	100-4118-531.41-04		2700 S 84 St	60.31
	WE ENERGIES	100-4201-535.41-04		3601 S 116 St	57.63
	WE ENERGIES	501-2601-537.41-04		Group bill	11,222.24
	WE ENERGIES	501-2601-537.41-04		2009 S 84 St	106.09
31068 - Summary					53,480.17
31069	WILSON, MARTIN	255-8101-521.56-03	I21548	WNOA	197.25

**Monthly Listing of Claims Paid
October 2022**

Check#	Vendor	GL Account	Proj No	Description	Amount
31069 - Summary					197.25
186226	AFLAC	100-0000-202.14-01		PAYROLL SUMMARY	54.77
186226 - Summary					54.77
186227	AIRGAS USA LLC	100-0000-141.01-00		PO# 144784	406.08
	AIRGAS USA LLC	100-0000-141.01-00		PO NUM 144784	105.51
186227 - Summary					511.59
186228	ALSTAR COMPANY	100-0000-141.01-00		PO NUM 145036	72.00
186228 - Summary					72.00
186229	AUTO PARTS & SERVICE INC	100-0000-141.01-00		PO NUM 144786	130.20
186229 - Summary					130.20
186230	BOWER'S PRODUCE	100-5007-552.38-01		OCTOBER SNAP TOKENS	557.00
	BOWER'S PRODUCE	100-5007-552.38-02		OCTOBER MMM COUPONS	520.00
186230 - Summary					1,077.00
186231	CCP INDUSTRIES	100-0000-141.01-00		PO NUM 145037	486.22
186231 - Summary					486.22
186232	CENTGRAF FARMS	100-5007-552.38-01		OCTOBER SNAP TOKENS	201.00
	CENTGRAF FARMS	100-5007-552.38-02		OCTOBER MMM COUPONS	239.00
186232 - Summary					440.00
186233	CHANG, FONG AND UE X	100-5007-552.38-01		OCTOBER SNAP TOKENS	398.00
186233 - Summary					398.00
186234	CINDY'S GREENHOUSE AND FRESH	100-5007-552.38-01		OCTOBER SNAP TOKENS	1,209.00
	CINDY'S GREENHOUSE AND FRESH	100-5007-552.38-02		OCTOBER MMM COUPONS	990.00
186234 - Summary					2,199.00
186235	CITY OF WEST ALLIS	100-0000-202.07-00		PAYROLL SUMMARY	66.00
186235 - Summary					66.00
186236	CORE AND MAIN	100-0000-141.01-00		PO NUM 144789	684.32
	CORE AND MAIN	501-0000-141.01-00		PO NUM 144789	3,689.75
186236 - Summary					4,374.07
186237	COUNTY LINE SUGAR BUSH	100-5007-552.38-01		OCTOBER SNAP TOKENS	78.00
	COUNTY LINE SUGAR BUSH	100-5007-552.38-02		OCTOBER MMM COUPONS	11.00
186237 - Summary					89.00
186238	CUMBERLAND SERVICENTER, INC	352-4201-535.70-03		PO# 144722	173,213.00
186238 - Summary					173,213.00
186239	DOBBERSTEIN LAW FIRM, LLC	100-0000-202.07-00		B TAKACH #2010SC004072	24.87
186239 - Summary					24.87
186240	DUERR, BRIAN	602-0000-229.04-00		DUERR, BRIAN	474.50
186240 - Summary					474.50
186241	DUERR, BRIAN	602-0000-229.04-00		DUERR, BRIAN	439.70
186241 - Summary					439.70
186242	ERTL, JOSEPH	100-5007-552.38-01		OCTOBER SNAP TOKENS	211.00
	ERTL, JOSEPH	100-5007-552.38-02		OCTOBER MMM COUPONS	195.00
186242 - Summary					406.00
186243	ESTATE OF GLORIA BAASKE	602-0000-229.04-00		BAASKE, GLORIA	249.93
186243 - Summary					249.93
186244	ESTATE OF GLORIA BAASKE	602-0000-229.04-00		BAASKE, GLORIA	249.93
186244 - Summary					249.93
186245	ESTATE OF GLORIA BAASKE	602-0000-229.04-00		BAASKE, GLORIA	249.93
186245 - Summary					249.93
186246	FASTENAL COMPANY	100-0000-141.01-00		PO# 144795	44.79
	FASTENAL COMPANY	100-0000-141.01-00		PO NUM 144795	160.18
186246 - Summary					204.97
186247	FER-LI MEATS & SAUSAGE LLC	100-5007-552.38-01		OCTOBER SNAP TOKENS	284.00
186247 - Summary					284.00
186248	FIRE COMPANY FUND	100-0000-202.16-00		PAYROLL SUMMARY	686.00
186248 - Summary					686.00
186249	GEXPRO	100-0000-141.01-00		PO NUM 144884	986.87
	GEXPRO	354-6051-517.31-02	M2220M	ELEC EQUIP&SUP(EXCPT CABL	2,171.13

**Monthly Listing of Claims Paid
October 2022**

Check#	Vendor	GL Account	Proj No	Description	Amount
186249	Summary				3,158.00
186250	GRAYBAR	100-0000-141.01-00		PO NUM 144799	2,696.60
186250	Summary				2,696.60
186251	HOEKSTRA'S MARKET & GREENHOUSE	100-5007-552.38-01		OCTOBER SNAP TOKENS	205.00
	HOEKSTRA'S MARKET & GREENHOUSE	100-5007-552.38-02		OCTOBER MMM COUPONS	201.00
186251	Summary				406.00
186252	HONEYWELL INTERNATIONAL INC	354-6051-517.31-01		PO# 144662	9,984.00
186252	Summary				9,984.00
186253	HYDROTEX	100-0000-141.01-00		PO NUM 145042	767.56
186253	Summary				767.56
186254	JERRY'S PRODUCE LLC	100-5007-552.38-01		OCTOBER SNAP TOKENS	197.00
	JERRY'S PRODUCE LLC	100-5007-552.38-02		OCTOBER MMM COUPONS	134.00
186254	Summary				331.00
186255	JOHNSON'S VEGETABLES	100-5007-552.38-01		OCTOBER SNAP TOKENS	336.00
	JOHNSON'S VEGETABLES	100-5007-552.38-02		OCTOBER MMM COUPONS	388.00
186255	Summary				724.00
186256	JX PETERBILT -WAUKESHA	100-0000-141.01-00		PO NUM 144801	455.90
186256	Summary				455.90
186257	KAESTNER AUTO ELECTRIC CO	100-0000-141.01-00		PO NUM 144802	115.81
186257	Summary				115.81
186258	KRAUS, RICHARD AND SUSAN	100-5007-552.38-01		OCTOBER SNAP TOKENS	37.00
	KRAUS, RICHARD AND SUSAN	100-5007-552.38-02		OCTOBER MMM COUPONS	100.00
186258	Summary				137.00
186259	KROKOWSKI'S FARM LLC	100-5007-552.38-01		OCTOBER SNAP TOKENS	61.00
	KROKOWSKI'S FARM LLC	100-5007-552.38-02		OCTOBER MMM COUPONS	119.00
186259	Summary				180.00
186260	LOCAL 342	100-0000-202.08-00		PAYROLL SUMMARY	7,552.09
186260	Summary				7,552.09
186261	MJ CONSTRUCTION INC	510-3803-536.75-01	MMSD09	PO# 144420	1,000.00
186261	Summary				1,000.00
186262	MOTOROLA SOLUTIONS INC	100-2101-521.44-04		RADIO COMMUNICATION,TELEP	3,086.00
186262	Summary				3,086.00
186263	NAPA AUTO PARTS- WEST ALLIS	100-0000-141.01-00		PO NUM 144816	281.77
186263	Summary				281.77
186264	NATIONAL BUSINESS FURNITURE LLC	100-0501-517.44-01		FURNITURE: OFFICE	505.55
	NATIONAL BUSINESS FURNITURE LLC	100-1301-517.51-02		FURNITURE: OFFICE	688.10
186264	Summary				1,193.65
186265	NEHER ELECTRIC SUPPLY INC	100-0000-141.01-00		PO NUM 144804	219.10
186265	Summary				219.10
186266	NORTH SHORE BOULANGEIE	100-5007-552.38-01		OCTOBER SNAP TOKENS	196.00
186266	Summary				196.00
186267	ONE FAMILY URBAN GARDENS	100-5007-552.38-01		OCTOBER SNAP TOKENS	34.00
	ONE FAMILY URBAN GARDENS	100-5007-552.38-02		OCTOBER MMM COUPONS	25.00
186267	Summary				59.00
186268	POLKA DOT PRODUCE	100-5007-552.38-01		OCTOBER SNAP TOKENS	87.00
	POLKA DOT PRODUCE	100-5007-552.38-02		OCTOBER MMM COUPONS	174.00
186268	Summary				261.00
186269	POLZIN FARMS	100-5007-552.38-01		OCTOBER SNAP TOKENS	102.00
	POLZIN FARMS	100-5007-552.38-02		OCTOBER MMM COUPONS	22.00
186269	Summary				124.00
186270	PROVANTAGE CORPORATION	100-1101-517.51-11		COMPUTER HDWR, PC	15,600.00
	PROVANTAGE CORPORATION	240-7913-542.51-11	H23014	COMPUTER HDWR, PC	5,200.00
186270	Summary				20,800.00
186271	Randy Williams	100-0000-229.04-00		2501 S 68 St	100.00
186271	Summary				100.00
186272	RIVER VALLEY RANCH LTD	100-5007-552.38-01		OCTOBER SNAP TOKENS	120.00
	RIVER VALLEY RANCH LTD	100-5007-552.38-02		OCTOBER MMM COUPONS	102.00
186272	Summary				222.00

Monthly Listing of Claims Paid
October 2022

Check#	Vendor	GL Account	Proj No	Description	Amount
186273	RNOW INC	100-0000-141.01-00		PO NUM 145043	55.02
	RNOW INC	100-0000-141.01-00		PO NUM 145040	558.00
186273 - Summary					613.02
186274	SALAMONE SUPPLIES	100-0000-141.01-00		PO NUM 144808	1,435.87
186274 - Summary					1,435.87
186275	SILVER MOON SPRINGS LLC III	100-5007-552.38-01		OCTOBER SNAP TOKENS	532.00
186275 - Summary					532.00
186276	T & A INDUSTRIAL LTD	100-0000-141.01-00		PO NUM 144813	566.09
186276 - Summary					566.09
186277	VANG, SHOUA	100-5007-552.38-01		OCTOBER SNAP TOKENS	157.00
	VANG, SHOUA	100-5007-552.38-02		OCTOBER MMM COUPONS	138.00
186277 - Summary					295.00
186278	VERMEER-WISCONSIN INC	100-0000-141.01-00		PO NUM 145041	64.44
186278 - Summary					64.44
186279	VISU-SEWER INC	510-3803-536.75-01	P2139N	PO# 144772	31,900.17
186279 - Summary					31,900.17
186280	WAPPA-PAC	100-0000-202.15-00		PAYROLL SUMMARY	26.00
186280 - Summary					26.00
186281	WEST ALLIS PROFESSIONAL POLICE	100-0000-202.08-00		PAYROLL SUMMARY	2,743.28
186281 - Summary					2,743.28
186282	WESTON AND WESTON	100-5007-552.38-01		OCTOBER SNAP TOKENS	284.00
	WESTON AND WESTON	100-5007-552.38-02		OCTOBER MMM COUPONS	122.00
186282 - Summary					406.00
186283	WITTE'S VEGETABLE MARKET LLC	100-5007-552.38-01		OCTOBER SNAP TOKENS	15.00
	WITTE'S VEGETABLE MARKET LLC	100-5007-552.38-02		OCTOBER MMM COUPONS	46.00
186283 - Summary					61.00
186284	XIONG'S PRODUCE	100-5007-552.38-01		OCTOBER SNAP TOKENS	159.00
	XIONG'S PRODUCE	100-5007-552.38-02		OCTOBER MMM COUPONS	76.00
186284 - Summary					235.00
186285	YANG, CHUE GE	100-5007-552.38-01		OCTOBER SNAP TOKENS	40.00
	YANG, CHUE GE	100-5007-552.38-02		OCTOBER MMM COUPONS	44.00
186285 - Summary					84.00
186286	YANG, PANG	100-5007-552.38-01		OCTOBER SNAP TOKENS	184.00
	YANG, PANG	100-5007-552.38-02		OCTOBER MMM COUPONS	115.00
186286 - Summary					299.00
186287	YOUA'S GARDEN	100-5007-552.38-01		OCTOBER SNAP TOKENS	93.00
	YOUA'S GARDEN	100-5007-552.38-02		OCTOBER MMM COUPONS	44.00
186287 - Summary					137.00
186288	Adam Just	100-0000-229.04-00		1339 S 103 St	100.00
186288 - Summary					100.00
186289	Adam Sims	100-0000-229.04-00		2375 S 82 St	100.00
186289 - Summary					100.00
186290	Advantage Remodel	100-0000-229.04-00		2041 S 93 St	100.00
186290 - Summary					100.00
186291	Alside Bldg Materials	100-0000-229.04-00		2634 S 88 St	100.00
186291 - Summary					100.00
186292	Anthem BC BS	100-0000-442.03-07		Hall, Damiya A	190.53
186292 - Summary					190.53
186293	Arnaldo Rosa	100-0000-229.04-00		2137 S 69 St	100.00
186293 - Summary					100.00
186294	ABT MAILCOM	100-2501-515.51-01		2022 Tax Bill Postage	11,000.00
186294 - Summary					11,000.00
186295	AECOM TECHNICAL SERVICES INC	540-1807-538.30-02		Storm water reviews	1,987.44
186295 - Summary					1,987.44
186296	AIRGAS USA LLC	100-2201-522.53-41		CYLINDER RENTAL INVOICE	311.79
186296 - Summary					311.79
186297	AMERICAN ADVANTAGE INSURANCE GROUP-	255-8101-521.30-04	I22534	Insurance	3,472.00

Monthly Listing of Claims Paid
October 2022

Check#	Vendor	GL Account	Proj No	Description	Amount
186297	Summary				3,472.00
186298	ANTAEUS LLC	100-2501-515.30-04		SEPT ANTAEUS INV	300.00
186298	Summary				300.00
186299	ASCENTIS CORPORATION	100-1101-517.32-01		Ascentis (Novatime)	4,567.80
186299	Summary				4,567.80
186300	AT & T LONG DISTANCE	255-8101-521.30-04	I22538	PEN 8268	800.00
	AT & T LONG DISTANCE	255-8101-521.30-04	I22538	PEN 7538	690.00
186300	Summary				1,490.00
186301	AT& T MOBILITY	255-8101-521.30-04	I22549	FirstNet	314.11
186301	Summary				314.11
186302	AT&T	100-1101-517.41-06		AT&T October	70.56
186302	Summary				70.56
186303	AT&T	255-8101-521.30-04	I22549	Phone LD	42.68
186303	Summary				42.68
186304	AT&T	255-8101-521.30-04	I22549	Phone	4,347.69
186304	Summary				4,347.69
186305	AURORA EAP	602-9101-517.30-04		EAP Sep-Nov 2022	3,234.00
186305	Summary				3,234.00
186306	Badger State Exteriors	100-0000-229.04-00		2251 S 63 ST	100.00
186306	Summary				100.00
186307	Badger Underground Inc	100-0000-229.04-00		2459 S 92 St	922.00
186307	Summary				922.00
186308	Badger Underground Inc	100-0000-229.04-00		2120 S 62 St	496.00
186308	Summary				496.00
186309	Boneck, Lyle	100-0000-442.03-07		Boneck, Lyle D	828.13
186309	Summary				828.13
186310	Breanna Viguera	100-0000-229.04-00		1533 S 60 St	100.00
186310	Summary				100.00
186311	Butters Fetting	100-0000-229.04-00		650 S 108 St	736.00
186311	Summary				736.00
186312	BAD CHARLIE, LLC	220-7526-565.31-02	C20510	Final Draw-CDBG ED LOAN	1,340.86
186312	Summary				1,340.86
186313	BATTERIES PLUS BULBS	100-2201-522.44-02		COT POWER LOAD BATTERY	220.45
186313	Summary				220.45
186314	BAYCOM	100-2201-522.44-01		(10) RADIO MICS	5,170.00
186314	Summary				5,170.00
186315	BILL'S POWER CENTER INC	100-4301-533.44-08		P-CV Hose	133.01
	BILL'S POWER CENTER INC	100-4301-533.44-08		Wheel & tire	205.94
186315	Summary				338.95
186316	BOUND TREE MEDICAL LLC	100-2201-522.53-41		MEDICAL SUPPLIES/ST 62	1,208.83
	BOUND TREE MEDICAL LLC	100-2201-522.53-41		MEDICAL SUPPLIES/ST 63	307.11
	BOUND TREE MEDICAL LLC	100-2201-522.53-41		MEDICAL SUPPLIES/ST 61	958.50
186316	Summary				2,474.44
186317	CornerstoneOne	100-0000-229.04-00		7030 W National Ave	2,119.50
186317	Summary				2,119.50
186318	CARLSON DETTMANN CONSULTING	100-1301-517.30-02		Lead Nutritionist Classif	275.00
186318	Summary				275.00
186319	CDW-G	255-8101-521.30-04	I22549	TelePres	434.00
	CDW-G	255-8101-521.30-04	I22549	MS EA	2,000.00
	CDW-G	255-8101-521.30-04	I22549	VEEAM licenses	9,542.25
	CDW-G	255-8101-521.51-09	I22549	Axis dome camera	663.53
	CDW-G	255-8101-521.51-09	I22549	Dock	759.06
186319	Summary				13,398.84
186320	CENGAGE LEARNING INC	100-3502-555.52-27		INVOICE #79301334	24.80
186320	Summary				24.80
186321	CHAPUT LAND SURVEYS, LLC	100-0302-516.30-05		Certified Survey Map CWA	4,250.00
186321	Summary				4,250.00

**Monthly Listing of Claims Paid
October 2022**

Check#	Vendor	GL Account	Proj No	Description	Amount
186322	CINTAS CORPORATION NO. 2	100-2101-521.51-07		Mops and mats 10/6	100.47
	CINTAS CORPORATION NO. 2	100-4101-533.51-09		CRT and Uniform 10/6	26.79
	CINTAS CORPORATION NO. 2	100-4101-533.51-09		CRT and Mop	9.67
	CINTAS CORPORATION NO. 2	100-4101-533.51-09		Mats DPW	114.27
	CINTAS CORPORATION NO. 2	100-4201-535.51-09		Uniforms 10/6/22	18.23
	CINTAS CORPORATION NO. 2	100-4501-533.51-09		Uniforms 10/6	163.60
	CINTAS CORPORATION NO. 2	501-2601-537.51-07		Uniforms 10/6	46.45
186322 - Summary					479.48
186323	CINTAS FIRE PROTECTION	100-4101-533.44-08		PD-Blair repair	540.00
186323 - Summary					540.00
186324	CITY OF WEST ALLIS	314-6601-563.31-60	T14010	15431-528844 TIF 14	747.08
186324 - Summary					747.08
186325	COMMUNITY PLANNING & DEVELOPMENT	220-7521-563.30-02	C22101	Plan & assist with IDIS	540.00
186325 - Summary					540.00
186326	CON-COR COMPANY INC	100-4218-531.44-08		Repair Parts	30.74
186326 - Summary					30.74
186327	CRAWDADDY'S ON GREENFIELD	200-1901-565.31-02		Mural - addl approval	1,250.00
186327 - Summary					1,250.00
186328	CRESCENT ELECTRIC SUPPLY COMPANY	100-4118-531.53-02		THHN-3-BLK-19STR-CU-RCL	151.90
186328 - Summary					151.90
186329	CUMMINS SALES AND SERVICE	100-2201-522.44-03		OIL PRESSURE REPAIR	1,017.70
	CUMMINS SALES AND SERVICE	255-8101-521.30-04	I22549	Generator maint.	347.37
186329 - Summary					1,365.07
186330	Dan Hanson	100-0000-229.04-00		2180 S 60 St	100.00
186330 - Summary					100.00
186331	Danielle Ransom	100-0000-229.04-00		2230 S 106 St	100.00
186331 - Summary					100.00
186332	David Balistreri	100-0000-229.04-00		2615 S 84 St	100.00
186332 - Summary					100.00
186333	Delta Partners	100-0000-229.04-00		2891 S 91 St	100.00
186333 - Summary					100.00
186334	DANOWSKI, DELILAH	255-8101-521.56-03	I21548	WNOA	51.00
186334 - Summary					51.00
186335	DASH MEDICAL GLOVES INC	100-2201-522.53-41		(6) CS EXAM GLOVES	569.40
	DASH MEDICAL GLOVES INC	100-2201-522.53-41		(4) CS EXAM GLOVES	379.60
186335 - Summary					949.00
186336	DIVERSIFIED BENEFIT SERVICES, INC	100-5219-517.21-15		Retiree HRA admin fees	100.00
186336 - Summary					100.00
186337	Exterior Pros	100-0000-229.04-00		2252 S 68 St	100.00
186337 - Summary					100.00
186338	EAGLE AUTOMOTIVE -MILWAUKEE	100-2110-521.44-03		parts	2,731.66
186338 - Summary					2,731.66
186339	EDWARD H. WOLF & SONS, INC.	100-4401-533.30-04		Bulk Oil System Repair	385.00
186339 - Summary					385.00
186340	EGOLDFAX	100-1101-517.30-13		eGoldFax September	128.00
186340 - Summary					128.00
186341	ELLIOTT'S ACE HARDWARE	100-2101-521.51-09		in store purchase	66.56
	ELLIOTT'S ACE HARDWARE	100-2201-522.44-03		RESERVE RIG REPAIR/ST 63	65.99
	ELLIOTT'S ACE HARDWARE	100-2201-522.51-04		CAN OPENER/ST 63	8.99
	ELLIOTT'S ACE HARDWARE	100-2201-522.51-06		DUST PAN/ST 63	13.49
	ELLIOTT'S ACE HARDWARE	100-2201-522.51-08		CONNECTOR/RIG PLUG-INS	34.18
	ELLIOTT'S ACE HARDWARE	100-2201-522.51-09		LIGHT BULBS/ST 63	12.59
186341 - Summary					201.80
186342	EMERGENCY LIGHTING &	100-2201-522.44-03		EMERGENCY LIGHT/#4208	156.00
186342 - Summary					156.00
186343	ENVIROTECH EQUIPMENT LLC	510-3801-536.53-02		bulldog manhole nozzle 1	3,035.00
186343 - Summary					3,035.00
186344	E3 DIAGNOSTICS, INC	100-3003-541.44-08		AUDIOMETER CALIBRATION	641.00

Monthly Listing of Claims Paid
October 2022

Check#	Vendor	GL Account	Proj No	Description	Amount
186344	Summary				641.00
186345	Four Seasons Property Mgmt	100-0000-229.04-00		1513 S 72 St	100.00
186345	Summary				100.00
186346	FACTUAL DATA	220-7534-563.31-01	C21312	Credit Report	36.80
186346	Summary				36.80
186347	FEDERAL EXPRESS CORP	100-3101-565.51-01		Inv adjusted per FedEx	33.06
186347	Summary				33.06
186348	FEDEX	255-8101-521.30-04	I22534	Shipping	12.28
186348	Summary				12.28
186349	FRANKLIN AGGREGATES INC	501-2707-537.44-56		3/8 chips	724.25
	FRANKLIN AGGREGATES INC	501-2708-537.44-57		3/8 chips	724.25
186349	Summary				1,448.50
186350	Geddy Krueger	100-0000-229.04-00		1554 S 74 St	100.00
186350	Summary				100.00
186351	Gene Wagner	100-0000-229.04-00		1743 S 57 ST	368.00
186351	Summary				368.00
186352	Gene Wagner	100-0000-229.04-00		S 56 ST	2,370.50
186352	Summary				2,370.50
186353	Gene Wagner	100-0000-229.04-00		9242 W National Ave	1,641.95
186353	Summary				1,641.95
186354	Gene Wagner	100-0000-229.04-00		8709 W Greenfield Ave	499.55
186354	Summary				499.55
186355	Gene Wagner Plumbing	100-0000-229.04-00		917 S 86 St	1,897.20
186355	Summary				1,897.20
186356	Gene Wagner Plumbing	100-0000-229.04-00		2882 S 103 St	1,794.60
186356	Summary				1,794.60
186357	Gene Wagner Plumbing	100-0000-229.04-00		1313 S 76 St	2,991.00
186357	Summary				2,991.00
186358	Gene Wagner Plumbing Co. Inc	100-0000-229.04-00		8713 W Greenfield Ave	499.55
186358	Summary				499.55
186359	Gruber Law Office	100-0000-442.03-07		Perez, Mary J	470.00
186359	Summary				470.00
186360	Guardian, Inc	100-0000-229.04-00		1628 S 78 St	100.00
186360	Summary				100.00
186361	GEAR WASH LLC	100-2201-522.60-01		PPE CLEANING/REPAIR	120.00
186361	Summary				120.00
186362	GEIGER INC	201-5101-517.51-12		Apparel	757.64
186362	Summary				757.64
186363	GRAYBAR	100-4118-531.53-02		1/4X1-3/4 HEX CONCRETE AN	59.52
186363	Summary				59.52
186364	GREEN BAY PIPE/TV AND BAYLAKE BANK	510-3803-536.30-04	P2237N	TV Contract - Sanitary	31,005.87
	GREEN BAY PIPE/TV AND BAYLAKE BANK	540-1807-538.30-04	P2237R	TV Contract - Storm	4,759.27
186364	Summary				35,765.14
186365	HC Contracting LLC	100-0000-229.04-00		1407 S 86 ST	100.00
186365	Summary				100.00
186366	HONEYWELL BUILDING SOLUTIONS	100-4101-533.44-08		HVAC-Fire-software repair	804.57
186366	Summary				804.57
186367	HOOPSTER PERFORMANCE INC	100-2110-521.44-03		parts	500.00
186367	Summary				500.00
186368	HUMANA WELLNESS	602-5601-517.30-04		Administrative Fee	1,158.85
	HUMANA WELLNESS	602-5601-517.30-04		Rewards from Prev. Month	2,755.00
186368	Summary				3,913.85
186369	Infinity Exteriors LLC	100-0000-229.04-00		1217 S 71 St	100.00
186369	Summary				100.00
186370	Infinity Exteriors LLC	100-0000-229.04-00		2004 S 72 St	100.00
186370	Summary				100.00
186371	IHN Co., Inc.	100-0000-229.04-00		1407 S 59 St	367.00

**Monthly Listing of Claims Paid
October 2022**

Check#	Vendor	GL Account	Proj No	Description	Amount
186371	Summary				367.00
186372	INFO USA MARKETING INC	100-3502-555.52-33		INVOICE #10004022824	1,022.40
186372	Summary				1,022.40
186373	J Gilbertson Exteriors	100-0000-229.04-00		7624 W Walker St	100.00
186373	Summary				100.00
186374	James Bintley	100-0000-229.04-00		2230 S 66 St	100.00
186374	Summary				100.00
186375	James Huttner	100-0000-229.04-00		2211 S 69 St	100.00
186375	Summary				100.00
186376	Janette Ellwitz	100-0000-423.01-00		permit refund	50.00
186376	Summary				50.00
186377	Joel Hoecherl	100-0000-229.04-00		6300 W Lincoln Ave	100.00
186377	Summary				100.00
186378	Joel Hoecherl	100-0000-229.04-00		6300 W Lincoln Ave	100.00
186378	Summary				100.00
186379	JEFFERSON FIRE & SAFETY INC	100-2201-522.60-01		(1) PAIR BOOTS	335.00
186379	Summary				335.00
186380	JOHN PAUL'S BUICK GMC INC	100-2110-521.44-03		parts	610.63
186380	Summary				610.63
186381	JOHNS DISPOSAL SERVICE	550-4233-535.41-09		september recycling	18,270.24
186381	Summary				18,270.24
186382	Katherine Blonski	100-0000-229.04-00		2743 S 96 ST	100.00
186382	Summary				100.00
186383	Kim T Thao	100-0000-229.04-00		1552 S 82 St	100.00
186383	Summary				100.00
186384	Kossow, Deborah	100-0000-442.03-07		Kossow, Deborah	690.00
186384	Summary				690.00
186385	KAESER COMPRESSORS	100-4501-533.30-04		Bldg. Air Comp. Repairs	2,225.96
186385	Summary				2,225.96
186386	KALLCENTS	255-8101-521.30-04	I22538	Q-card service	21.45
186386	Summary				21.45
186387	Lefever Roofing	100-0000-229.04-00		2006 S 54 St	100.00
186387	Summary				100.00
186388	LAKESIDE INTERNATIONAL TRUCKS INC	100-4218-531.44-08		Repair Parts	1,469.29
	LAKESIDE INTERNATIONAL TRUCKS INC	540-1801-538.44-08		Air dryer assembly	299.38
186388	Summary				1,768.67
186389	LALONDE CONTRACTORS INC	350-6008-531.31-01	P2220S	W Washington St-Streets	3,044.41
	LALONDE CONTRACTORS INC	350-6008-531.31-01	P2221S	S 77 St-Streets	29,319.19
	LALONDE CONTRACTORS INC	350-6008-531.31-01	P2223S	S 66 St-Streets	11,145.88
	LALONDE CONTRACTORS INC	350-6008-531.31-01	P2224S	S 57 St-Streets	104,175.15
	LALONDE CONTRACTORS INC	350-6008-531.31-01	P2229S	W Madison St-Streets	24,826.90
	LALONDE CONTRACTORS INC	501-2901-537.75-01	P2220H	W Washington St-Water	102,818.50
	LALONDE CONTRACTORS INC	501-2901-537.75-01	P2221H	S 77 St-Water	40,230.12
	LALONDE CONTRACTORS INC	501-2901-537.75-01	P2229H	W Madison St-Water	16,058.32
	LALONDE CONTRACTORS INC	510-3803-536.75-01	P2220N	W Washington St-Sanitary	20,473.45
	LALONDE CONTRACTORS INC	510-3803-536.75-01	P2229N	W Madison St-Sanitary	8,438.80
	LALONDE CONTRACTORS INC	540-1807-538.75-01	P2220R	W Washington St-Storm	26,830.85
	LALONDE CONTRACTORS INC	540-1807-538.75-01	P2221R	S 77 St-Storm	99,365.25
	LALONDE CONTRACTORS INC	540-1807-538.75-01	P2223G	S 66 St-Green Infrastruct	14,104.17
	LALONDE CONTRACTORS INC	540-1807-538.75-01	P2224R	S 57 St-Storm	(36,554.10)
	LALONDE CONTRACTORS INC	540-1807-538.75-01	P2229R	W Madison St-Storm	6,954.00
186389	Summary				471,230.89
186390	LAND TITLE SERVICES INC	100-2401-524.30-04		10600 Blk Greenfield Ave	110.00
	LAND TITLE SERVICES INC	100-2401-524.30-04		10620 W Greenfield Ave	110.00
186390	Summary				220.00
186391	LEE MECHANICAL	100-4101-533.44-08		HBAC-CH-repairs	873.29
	LEE MECHANICAL	100-4101-533.44-08		HVAC-DPW-repair	315.00
186391	Summary				1,188.29
186392	LIFE-ASSIST, INC	100-2201-522.53-41		MEDICAL SUPPLIES/ST 63	621.49

Monthly Listing of Claims Paid
October 2022

Check#	Vendor	GL Account	Proj No	Description	Amount
186392	LIFE-ASSIST, INC	100-2201-522.53-41		MEDICAL SUPPLIES/ST 62	1,008.88
	LIFE-ASSIST, INC	100-2201-522.53-41		MEDICAL SUPPLIES/ST 61	682.78
186392 - Summary					2,313.15
186393	LOESCH, JEREMY	255-8101-521.56-03	I22534	Pittsburgh	1,140.89
186393 - Summary					1,140.89
186394	LOPEZ, MICHAEL	255-8101-521.56-03	I21548	WNOA	558.50
186394 - Summary					558.50
186395	LUTHERAN SOCIAL SERVICES OF WI	222-7604-563.30-04		Monthly invoice	3,575.47
186395 - Summary					3,575.47
186396	Margaret Jacobs	100-0000-229.04-00		947 S 58 St	100.00
186396 - Summary					100.00
186397	Mckenzie, Tracy L	100-0000-442.03-07		Mckenzie, Tracy L	792.24
186397 - Summary					792.24
186398	Moore, Nancy	100-0000-442.03-07		Moore, Nancy C	1,113.76
186398 - Summary					1,113.76
186399	MACEMON & SONS INC	220-7522-563.31-01	C21410	1475 S 94th St Demo	2,367.13
186399 - Summary					2,367.13
186400	MADACC	100-8802-517.58-02		Q4 Capital Proj-MADACC	514.63
	MADACC	100-8802-517.58-02		Q4 Operating Costs-MADACC	40,423.80
	MADACC	100-8802-517.58-02		Debt Service-2nd Install	10,932.72
186400 - Summary					51,871.15
186401	MANNEDGE CONSULTING, LLC	255-8101-521.30-04	I22534	Consulting	2,000.00
186401 - Summary					2,000.00
186402	MANSKE PROCESS & INVESTIGATIONS LLC	100-0302-516.30-05		INV#217	210.00
	MANSKE PROCESS & INVESTIGATIONS LLC	100-0302-516.30-05		Inv#218	35.00
186402 - Summary					245.00
186403	MARCO TECHNOLOGIES, LLC	100-1101-517.30-02		Macro replace server fan	102.00
186403 - Summary					102.00
186404	MENARDS - WEST ALLIS	100-4118-531.53-02		1/2X2X4 AC2 AG	18.39
186404 - Summary					18.39
186405	MENARDS- WEST MILWAUKEE	100-4118-531.53-02		SCKT ADAPTER	9.96
186405 - Summary					9.96
186406	MIDLAND PAPER	260-8202-517.51-02		paper	371.68
186406 - Summary					371.68
186407	MIDWEST TAPE	100-3502-555.52-22		INVOICE #502765764	401.90
186407 - Summary					401.90
186408	MILWAUKEE CNTY REG OF DEEDS	220-7534-563.31-01	C21313	recording financial docs	30.00
	MILWAUKEE CNTY REG OF DEEDS	224-7701-563.31-02		recording financial docs	30.00
	MILWAUKEE CNTY REG OF DEEDS	397-0000-129.00-00		recording financial docs	30.00
186408 - Summary					90.00
186409	MILWAUKEE COUNTY CLERK OF COURTS	100-0000-229.11-10		bail	5,700.00
186409 - Summary					5,700.00
186410	MILWAUKEE COUNTY TREASURER	100-0000-451.01-00		Sept Court Fines	9,337.04
186410 - Summary					9,337.04
186411	MILWAUKEE JOURNAL SENTINEL	100-0302-516.30-05		West Allis City Of-Legals	767.46
186411 - Summary					767.46
186412	MISC-ENG PERMIT REFUNDS	100-0000-229.04-00		1313 S 96 ST	0.00
186412 - Summary					0.00
186413	MOTION INDUSTRIES	550-4233-535.44-08		seals	40.22
186413 - Summary					40.22
186414	New Berlin Grading, Inc	100-0000-229.04-00		W Cleveland Ave & S 112 S	367.00
186414 - Summary					367.00
186415	NAPA AUTO PARTS- WEST ALLIS	100-2110-521.44-03		parts	712.42
	NAPA AUTO PARTS- WEST ALLIS	100-4101-533.44-08		Fuel filter	28.99
	NAPA AUTO PARTS- WEST ALLIS	100-4101-533.44-08		Flasher	17.79
	NAPA AUTO PARTS- WEST ALLIS	100-4301-533.44-08		Air filter	104.31
	NAPA AUTO PARTS- WEST ALLIS	100-4301-533.44-08		Repair Parts	86.52
	NAPA AUTO PARTS- WEST ALLIS	100-4501-533.44-08		Shop Supplies	30.99

**Monthly Listing of Claims Paid
October 2022**

Check#	Vendor	GL Account	Proj No	Description	Amount
186415	NAPA AUTO PARTS- WEST ALLIS	501-2901-537.44-03		Dex cool antifreeze	13.49
	NAPA AUTO PARTS- WEST ALLIS	501-2901-537.44-03		Front brake pads	62.50
	NAPA AUTO PARTS- WEST ALLIS	501-2901-537.44-03		CV boot clamps	4.34
	NAPA AUTO PARTS- WEST ALLIS	510-3801-536.44-08		Radiator hose	285.11
	NAPA AUTO PARTS- WEST ALLIS	550-4233-535.44-08		Air filter 6770	170.95
186415 - Summary					1,517.41
186416	NETWORK HEALTH ADMIN SERVICES, LLC	603-9130-517.21-83		FSP Sept admin fee Retire	150.00
	NETWORK HEALTH ADMIN SERVICES, LLC	603-9130-517.21-83		FSP Sept admin fee	475.00
186416 - Summary					625.00
186417	ORKIN, LLC	220-7522-563.30-04	C22220	WA Vermin Abatement	765.00
186417 - Summary					765.00
186418	OSI ENVIRONMENTAL INC	550-4233-535.41-09		antifreeze disposal	191.25
	OSI ENVIRONMENTAL INC	550-4233-535.41-09		uncrushed filters	45.00
186418 - Summary					236.25
186419	Patrick Pajot	100-0000-229.04-00		1536 S 58 St	100.00
186419 - Summary					100.00
186420	Paul Schuessler	100-0000-229.04-00		1232 S 74 St	100.00
186420 - Summary					100.00
186421	Phillip Heston	100-0000-229.04-00		6220 W National Ave	100.00
186421 - Summary					100.00
186422	PACER SERVICE CENTER	100-0303-516.52-01		Acct#2702654 (7/1-9/30/22)	40.00
186422 - Summary					40.00
186423	PLYMOUTH LUBRICANTS	100-2110-521.53-02		parts	4,079.80
186423 - Summary					4,079.80
186424	POMP'S TIRE SERVICE INC	100-2110-521.53-03		parts	1,467.29
186424 - Summary					1,467.29
186425	PORT-A-JOHN INC	100-4101-533.32-04		Vets Park PAJ to 11/6/22	151.00
	PORT-A-JOHN INC	100-4101-533.32-04		LH-PAJ to 11/6/22	151.00
	PORT-A-JOHN INC	100-4101-533.32-04		Skate Park-PAJ to 10/14/2	103.00
	PORT-A-JOHN INC	100-4101-533.32-04		Mckinley Park-PAJ to 11/6	151.00
	PORT-A-JOHN INC	100-4101-533.32-04		Rogers park-PAJ 11/6/22	103.00
	PORT-A-JOHN INC	100-4201-535.30-04		Trans. Stn. PortAJohn	103.00
	PORT-A-JOHN INC	550-4233-535.32-03		Morgan PortAJohn	103.00
186425 - Summary					865.00
186426	PRIORITY DISPATCH CORPORATION	100-2107-521.57-02		dispatch training	550.00
186426 - Summary					550.00
186427	PRO ELECTRIC INC	354-6051-517.31-01	M2220M	Street Lighting N-4	203,854.74
186427 - Summary					203,854.74
186428	PUBLIC SERVICE COMMISSION OF WI	501-2901-537.58-01		22-23 PSC UTIL ADV ASSMT	8,259.74
186428 - Summary					8,259.74
186429	Randy Miller Inc	100-0000-229.04-00		733 S 94 ST	100.00
186429 - Summary					100.00
186430	Red River Construction	100-0000-229.04-00		2415 S 66 St	100.00
186430 - Summary					100.00
186431	Robinson, Diamond S	100-0000-442.03-07		Robinson, Diamond S	1,003.00
186431 - Summary					1,003.00
186432	Rozga Plumbing Corp	100-0000-229.04-00		2317 S 77 ST	1,144.85
186432 - Summary					1,144.85
186433	Rozga Plumbing Corp	100-0000-229.04-00		2890 S 104 St	1,495.50
186433 - Summary					1,495.50
186434	Rozga Plumbing Corp	100-0000-229.04-00		904 S 87 St	1,439.55
186434 - Summary					1,439.55
186435	RAY'S TOWING	100-4201-535.44-08		Towing to Peterbilt Wauk.	590.63
186435 - Summary					590.63
186436	REINDERS INC	100-4301-533.44-08		Return Credit	(197.37)
	REINDERS INC	100-4301-533.44-08		Repair Parts	294.55
186436 - Summary					97.18
186437	RELIANT FIRE APPARATUS INC	100-2201-522.44-03		SEAT BELT#4209	147.25

Monthly Listing of Claims Paid
October 2022

Check#	Vendor	GL Account	Proj No	Description	Amount
186437	RELIANT FIRE APPARATUS INC	100-2201-522.44-03		U-JOINT/#4209	262.83
	RELIANT FIRE APPARATUS INC	100-2201-522.44-03		LIGHT REPAIR/#4208	24.01
186437 - Summary					434.09
186438	RENNERT'S FIRE EQUIPMENT SERVICE	100-2201-522.32-04		PREVENTATIVE MAINTENANCE	491.48
186438 - Summary					491.48
186439	RICOH USA INC	255-8101-521.30-04	I22549	Copier maint.	438.60
186439 - Summary					438.60
186440	RITTER TECHNOLOGY LLC	100-2201-522.51-08		SHOP AIR HOSE REPAIRS	497.93
	RITTER TECHNOLOGY LLC	100-4301-533.44-08		Repair Parts	97.85
186440 - Summary					595.78
186441	RNOW INC	540-1801-538.44-08		Repair Parts	7,360.32
186441 - Summary					7,360.32
186442	RUZINSKI, ANNA	255-8101-521.56-03	I22534	Pittsburgh	1,021.91
186442 - Summary					1,021.91
186443	Schears, Daniel	100-0000-442.03-07		Schears, Daniel E	2,067.10
186443 - Summary					2,067.10
186444	Sergio Amaya	100-0000-229.04-00		2251 S 63 St	100.00
186444 - Summary					100.00
186445	Sidello Property	100-0000-229.04-00		2103 S 82 St	100.00
186445 - Summary					100.00
186446	SEAGRAVE FIRE APPARATUS LLC	100-2201-522.44-03		WHEEL CHOCK/#4305	240.50
186446 - Summary					240.50
186447	SECURIAN FINANCIAL GROUP INC	100-5209-517.21-04		Life premiums NOV	15,523.13
186447 - Summary					15,523.13
186448	SEH INC	501-0000-229.17-01		T-Mobile 84 & National	765.79
	SEH INC	501-0000-229.17-02		ATT 116 & Rogers	3,035.35
	SEH INC	501-0000-449.09-00		ATT 116 & Rogers	(3,035.35)
	SEH INC	501-0000-449.09-00		T-Mobile 84 & National	(765.79)
	SEH INC	501-2706-537.30-02		ATT 116 & Rogers	3,035.35
	SEH INC	501-2706-537.30-02		T-Moblie 84 & National	765.79
186448 - Summary					3,801.14
186449	SHERWIN WILLIAMS	100-4101-533.53-02		reflective glass beads	1,120.00
186449 - Summary					1,120.00
186450	SHERWIN WILLIAMS	100-4101-533.44-08		Additional needed repairs	195.00
186450 - Summary					195.00
186451	SIDELLO PROPERTY SERVICES INC	100-2406-524.30-04	A11111	2340 S 78 St	1,119.75
	SIDELLO PROPERTY SERVICES INC	100-2406-524.30-31		Grass cutting	2,520.00
186451 - Summary					3,639.75
186452	SIGNARAMA	100-4101-533.53-02		Panhandling-76/Oklahoma	260.88
186452 - Summary					260.88
186453	SPIELBAUER FIREWORKS CO INC	257-5701-517.51-09	SP0001	City Fireworks Display	15,000.00
186453 - Summary					15,000.00
186454	STARK PAVEMENT CORP	100-4218-531.53-02		3/8 surface	74.39
	STARK PAVEMENT CORP	501-2707-537.53-08		3/8 surface	163.13
	STARK PAVEMENT CORP	540-1801-538.53-02		3/8 surface	578.77
186454 - Summary					816.29
186455	STATE OF WISCONSIN	100-0000-451.01-00		Sept Court Fines	21,304.91
186455 - Summary					21,304.91
186456	STENSTROM PETROLEUM SERVICES GROUP	100-4401-533.30-04		Fuel Island Repair	1,004.68
186456 - Summary					1,004.68
186457	SUPERION, LLC	100-1101-517.32-01		Naviline Inv-06 Nov 2022	12,611.00
186457 - Summary					12,611.00
186458	T-MOBILE USA, INC.	255-8101-521.30-04	I22538	Pen 1227	315.00
	T-MOBILE USA, INC.	255-8101-521.30-04	I22538	Pen 4401	315.00
	T-MOBILE USA, INC.	255-8101-521.30-04	I22538	PEN 6159	315.00
	T-MOBILE USA, INC.	255-8101-521.30-04	I22538	GPS 1484	100.00
186458 - Summary					1,045.00
186459	The Window Store Inc	100-0000-229.04-00		2125 S 77 St	100.00

Monthly Listing of Claims Paid
October 2022

Check#	Vendor	GL Account	Proj No	Description	Amount
186459	Summary				100.00
186460	Timothy Futh	100-0000-229.04-00		1418 S 79 St	100.00
186460	Summary				100.00
186461	TAPCO	100-2101-521.32-01		September	375.00
186461	Summary				375.00
186462	THOMSON REUTERS - WEST	100-0303-516.52-01		Acct#1000616368	515.15
186462	Summary				515.15
186463	TIME WARNER CABLE	100-1101-517.41-06		Spectrum - September	884.38
186463	Summary				884.38
186464	TRANS UNION LLC	100-2110-521.44-03		parts	122.18
186464	Summary				122.18
186465	TRI CITY NATIONAL BANK	220-7521-563.30-04	C22101	TCNB Loan Servicing Fees	56.00
	TRI CITY NATIONAL BANK	224-7701-563.30-04		TCNB Loan Servicing Fees	35.00
	TRI CITY NATIONAL BANK	396-6301-563.30-07		TCNB Loan Servicing Fees	5.00
	TRI CITY NATIONAL BANK	397-6301-563.30-07		TCNB Loan Servicing Fees	18.00
186465	Summary				114.00
186466	TWO DAY PAINTING, LLC	100-4101-533.44-08		CH-Rm128-ceiling paint-de	600.00
186466	Summary				600.00
186467	UPS	100-1401-515.51-01		Monthly fees from UPS	93.88
186467	Summary				93.88
186468	USAA	100-0000-442.03-11		Leverance, Richard L	500.00
186468	Summary				500.00
186469	USI INSURANCE SERVICES, LLC	602-9101-517.30-02		November 2022	5,416.66
186469	Summary				5,416.66
186470	VAN ELLS, MATTHEW	255-8101-521.56-03	I21548	WNOA	129.00
186470	Summary				129.00
186471	VEOLIA	255-8101-521.51-09	I22538	Labpack	2,891.60
186471	Summary				2,891.60
186472	VERIZON WIRELESS	255-8101-521.30-04	I22549	Cell service	3,062.80
186472	Summary				3,062.80
186473	VERIZON WIRELESS SERVICES	255-8101-521.30-04	I22538	PLU 8167	345.00
	VERIZON WIRELESS SERVICES	255-8101-521.30-04	I22538	PEN 3515	180.00
	VERIZON WIRELESS SERVICES	255-8101-521.30-04	I22538	Pen 1250	168.00
186473	Summary				693.00
186474	VERIZON WIRELESS-VSAT	255-8101-521.30-04	I22538	PLU 3515	300.00
186474	Summary				300.00
186475	VERMEER-WISCONSIN INC	501-2901-537.44-03		Repair Parts	74.04
186475	Summary				74.04
186476	WAUKESHA CO TECHNICAL COLLEGE	100-2107-521.57-02		SWAT Training	1,089.57
186476	Summary				1,089.57
186477	WEST MICHIGAN INVESTMENTS, LLC	255-8101-521.43-03	I22534	Nov 22 rent	47,406.60
186477	Summary				47,406.60
186478	WINDSTREAM	255-8101-521.30-04	I22549	Internet	9,691.19
186478	Summary				9,691.19
186479	WISCONSIN DEPT OF TRANSPORTATION	350-6008-531.31-01	P1829S	DOT construction Natl 70	181,021.88
	WISCONSIN DEPT OF TRANSPORTATION	350-6008-531.31-01	P2130T	Linc const road	1,680.82
	WISCONSIN DEPT OF TRANSPORTATION	350-6008-531.31-01	P2238T	76 Becher Traffic signals	21,376.03
	WISCONSIN DEPT OF TRANSPORTATION	350-6008-531.31-01	P2240T	Lincoln 93-95 Sig Street	18,773.44
	WISCONSIN DEPT OF TRANSPORTATION	501-2901-537.75-01	P2130H	Linc const water	0.09
	WISCONSIN DEPT OF TRANSPORTATION	501-2901-537.75-01	P2238H	76 Becher Traffic signals	3,452.39
	WISCONSIN DEPT OF TRANSPORTATION	501-2901-537.75-01	P2240H	Lincoln 93-95 Sig Water	1,652.72
	WISCONSIN DEPT OF TRANSPORTATION	510-3803-536.75-01	P2130N	Linc const sanitary	0.67
	WISCONSIN DEPT OF TRANSPORTATION	510-3803-536.75-01	P2238N	76 Becher Traffic signals	226,907.10
	WISCONSIN DEPT OF TRANSPORTATION	510-3803-536.75-01	P2240N	Lincoln 93-95 Sig Sanitar	7,726.96
	WISCONSIN DEPT OF TRANSPORTATION	540-1807-538.75-01	P2130R	Linc const storm	62.76
	WISCONSIN DEPT OF TRANSPORTATION	540-1807-538.75-01	P2238R	76 Becher Traffic signals	1,007.24
	WISCONSIN DEPT OF TRANSPORTATION	540-1807-538.75-01	P2240R	Lincoln 93-95 Sig Storm	3,469.97
186479	Summary				467,132.07
186480	WISCONSIN LIFTING SPECIALISTS INC	100-4501-533.44-08		Truck Supplies, Wrecker	472.53

Monthly Listing of Claims Paid
October 2022

Check#	Vendor	GL Account	Proj No	Description	Amount
186480 - Summary					472.53
186481	WOLF PAVING COMPANY, INC	350-6008-531.31-01	P2225S	W Vigo Terr-Streets	17,370.99
	WOLF PAVING COMPANY, INC	350-6008-531.31-01	P2226S	S 91 St-Streets	23,525.89
	WOLF PAVING COMPANY, INC	350-6008-531.31-01	P2228S	W Becher St-Streets	145,594.34
	WOLF PAVING COMPANY, INC	350-6008-531.31-01	P2230S	W Orchard St-Streets	80,824.77
	WOLF PAVING COMPANY, INC	350-6008-531.31-01	P2231S	W Hayes St-Streets	38,908.61
	WOLF PAVING COMPANY, INC	501-2901-537.75-01	P2226H	S 91 St-Water	142.50
	WOLF PAVING COMPANY, INC	510-3803-536.75-01	P2225N	W Vigo Terr-Sanitary	1,235.00
	WOLF PAVING COMPANY, INC	510-3803-536.75-01	P2226N	S 91 St-Sanitary	3,111.25
	WOLF PAVING COMPANY, INC	510-3803-536.75-01	P2230N	W Orchard St-Sanitary	3,111.25
	WOLF PAVING COMPANY, INC	510-3803-536.75-01	P2231N	W Hayes St-Sanitary	7,951.50
	WOLF PAVING COMPANY, INC	540-1807-538.75-01	P2225R	W Vigo Terr-Storm	1,643.50
	WOLF PAVING COMPANY, INC	540-1807-538.75-01	P2226R	S 91 St-Storm	3,158.75
	WOLF PAVING COMPANY, INC	540-1807-538.75-01	P2230R	W Orchard St-Storm	2,042.50
	WOLF PAVING COMPANY, INC	540-1807-538.75-01	P2231R	W Hayes St-Storm	3,814.25
186481 - Summary					332,435.10
186482	ZIGNEGO READY MIX INC	501-2707-537.53-08		1.25 base course	129.00
186482 - Summary					129.00
186483	ZOLL MEDICAL CORPORATION	100-2201-522.53-41		MEDICALS SUPPLIES/ST 61	72.00
	ZOLL MEDICAL CORPORATION	100-2201-522.53-41		MEDICAL SUPPLIES/ST 61	216.00
186483 - Summary					288.00
10/21/2022 - Summary					2,275,746.48

Payment Date: 10/24/2022

Check#	Vendor	GL Account	Proj No	Description	Amount
31070	BAILEY, KENT	255-8101-521.56-03	I22534	Pittsburgh travel (MN)	2,034.09
31070 - Summary					2,034.09
31071	DAVIES, CHERYL	240-7904-542.56-02	H22004	ORLANDO CONFERENCE	696.09
31071 - Summary					696.09
31072	GRAINGER	100-4218-531.44-08		Repair Parts	55.28
31072 - Summary					55.28
31073	HOPPE, MELLENA	222-7601-563.56-01		mileage	261.84
	HOPPE, MELLENA	222-7601-563.56-02		travel expense	286.25
31073 - Summary					548.09
31074	LEUNG, FRANK	100-0302-516.61-02	WA4201	Settle PD Claim	52.75
31074 - Summary					52.75
31075	LOR, CHANSOUDA	100-3004-541.57-01		CPO TRAINING TRAVEL	118.00
31075 - Summary					118.00
31076	SCHLIEVE, TIMOTHY	100-5212-517.30-04		DPW Safety Shoe Reimb.	111.95
31076 - Summary					111.95
31077	SKROBACK, AARON	100-5212-517.30-04		DPW Safety Shoe Reimb.	150.00
31077 - Summary					150.00
186484	BLUE RIBBON ORGANICS	540-1801-538.41-09		yard waste	13,458.31
	BLUE RIBBON ORGANICS	550-4233-535.41-09		brush	16,212.86
186484 - Summary					29,671.17
186485	CDW-G	255-8101-521.51-09	I22549	Docks	2,103.71
186485 - Summary					2,103.71
186486	CITY OF MILWAUKEE-PUBLIC WORKS	350-6008-531.31-02	FR2101	HAST 72 trail design Milw	1,387.02
186486 - Summary					1,387.02
186487	CLIFTONLARSONALLEN LLP	100-8812-517.30-01		2021 single audit svcs	8,400.00
186487 - Summary					8,400.00
186488	EAGLE ENGRAVING	100-2201-522.60-01		67 TAGS/POSTAGE	112.20
186488 - Summary					112.20
186489	EDWARD H. WOLF & SONS, INC.	100-4501-533.53-01		Unleaded and Diesel Fuel	30,014.52
186489 - Summary					30,014.52
186490	ELLIOTT'S ACE HARDWARE	100-2201-522.51-08		SHOP ITEMS/ST 62	1.18
	ELLIOTT'S ACE HARDWARE	100-2201-522.53-27		(1) PALLET/OIL ZORB	910.58
186490 - Summary					911.76
186491	EXPRESS ELEVATOR LLC	100-4101-533.32-04		Elevator 9/2022-6 (not 8)	405.00

**Monthly Listing of Claims Paid
October 2022**

Check#	Vendor	GL Account	Proj No	Description	Amount
186491	Summary				405.00
186492	HUFF-N-PUFF FITNESS REPAIR LLC	100-3401-544.30-04		FITNESS EQUIPMENT REPAIR	264.00
186492	Summary				264.00
186493	HUMANA WELLNESS	602-5601-517.30-04		Administrative Fee	1,162.70
	HUMANA WELLNESS	602-5601-517.30-04		Go365 Rewards	5,230.00
186493	Summary				6,392.70
186494	Jessica Nankin	100-0000-441.12-00		refund	4.00
186494	Summary				4.00
186495	Jessica Nankin	100-0000-421.11-00		refund	106.00
186495	Summary				106.00
186496	JX PETERBILT -WAUKESHA	550-4233-535.44-08		Repair Parts	40.99
	JX PETERBILT -WAUKESHA	550-4233-535.44-08		Rear brake caliper	1,808.29
186496	Summary				1,849.28
186497	KAESTNER AUTO ELECTRIC CO	100-2201-522.44-03		ALTERNATOR/FREIGHT/#4211	3,245.00
186497	Summary				3,245.00
186498	LALONDE CONTRACTORS INC	350-6008-531.31-01	FR2101	HAST 72 Connection	32,488.59
186498	Summary				32,488.59
186499	MACQUEEN EQUIPMENT	100-2201-522.44-02		HURST EQUIP REPAIR	349.50
	MACQUEEN EQUIPMENT	540-1801-538.44-08		Repair Parts	1,710.73
	MACQUEEN EQUIPMENT	540-1801-538.44-08		Return Credit	(510.98)
	MACQUEEN EQUIPMENT	540-1801-538.44-08		Controller	629.24
186499	Summary				2,178.49
186500	MAXIM HEALTHCARE STAFFING SERVICES,	240-7937-542.30-03	EF2105	COVID Vaccinators	1,365.00
186500	Summary				1,365.00
186501	NAPA AUTO PARTS- WEST ALLIS	100-2201-522.53-01		OIL/OIL FILTER/#4148	76.83
	NAPA AUTO PARTS- WEST ALLIS	100-2201-522.53-01		HUB OIL/#4415	29.18
186501	Summary				106.01
186502	ORKIN, LLC	220-7522-563.30-04	C22220	WA Vermin Abatement	765.00
186502	Summary				765.00
186503	RELIANCE STANDARD LIFE INSURANCE CO	100-5217-517.21-11		LTD Nov premiums	5,549.96
186503	Summary				5,549.96
186504	RUPENA'S FINE FOODS	273-8453-563.31-02	CV2002	Rupenas- Forgivable Loan	0.00
186504	Summary				0.00
186505	SUPERIOR VISION INSURANCE INC	100-5218-517.21-12		October Vision premium	1,251.22
186505	Summary				1,251.22
186506	TRI CITY NATIONAL BANK	100-0000-229.16-00		October loan payments	485.76
186506	Summary				485.76
186507	TRUCK COUNTRY	100-4218-531.44-08		Headlight studs	9.36
	TRUCK COUNTRY	100-4218-531.44-08		Repair Parts	174.59
	TRUCK COUNTRY	100-4301-533.44-08		INVOICE DOUBLE PAID	(5.82)
186507	Summary				178.13
186508	WASTEBUILT	100-4201-535.44-08		Repair Parts	301.21
186508	Summary				301.21
186509	WI DEPT OF REVENUE	100-0501-517.30-04		Manf assessment municipal	4,613.45
186509	Summary				4,613.45
186510	WIS DEPARTMENT OF ADMINISTRATION	100-0000-445.01-00		Quarter 3- 2022	25,303.00
186510	Summary				25,303.00
186511	ZENITH ROOFING AND CONSTRUCTION LLC	220-7534-563.31-01	C21313	contractor payment - roof	12,700.00
186511	Summary				12,700.00
10/24/2022 - Summary					175,918.43
Overall - Summary					4,298,323.16

**CITY OF WEST ALLIS
RESOLUTION R-2022-0795**

**RESOLUTION AUTHORIZING ECONOMIC DEVELOPMENT TO FUND \$32,000
FOR BUBLR BIKES OPERATION IN 2022 AND 2023 CALENDAR YEARS**

WHEREAS, the Economic Development has a mission and goal to help foster redevelopment and regional growth; and,

WHEREAS, Bublr Bikes has requested financial support for Bublr Bikes operations in West Allis for calendar year 2022 and 2023; and,

WHEREAS, in past years, the First-Ring Industrial Redevelopment Enterprise, Inc. (F.I.R.E.), Board of Directors discussed and approved funding \$8,000 for Bublr Bikes operations in years 2020-22 calendar year combined with an additional \$8,000 of private support: and,

WHEREAS, West Allis ridership has increased and along with a renewed emphasis of the City to become more walkable and bikeable as a City Strategic Goal; and,

WHEREAS, the financial support would be provided by funds within the Economic Development (FIRE) Funds that are supported by financial support through a First-Ring Industrial Redevelopment Enterprise, Inc.

NOW THEREFORE, BE IT RESOLVED by the Common Council of the City of West Allis:

1. That the Executive Director of Economic Development, or his designee, is hereby authorized and directed to execute the fund \$32,000 for Bublr Bikes operations in 2022 and 2023 calendar years.

2. That the Executive Director of Economic Development, or his designee, along with the approval of the is hereby authorized to make such non-substantive changes, modifications, additions and deletions to and from the various provisions of the Professional Services Contract, including any and all attachments, exhibits, addendums and amendments, as may be necessary and proper to correct inconsistencies, eliminate ambiguity and otherwise clarify and supplement said provisions to preserve and maintain the general intent thereof, and to prepare and deliver such other and further documents as may be reasonably necessary to complete the transactions contemplated therein.

NOW THEREFORE BE IT RESOLVED by the Common Council hereby approves and allocates \$32,000 for Bublr Bikes operations in 2022 and 2023.

SECTION 1: **ADOPTION** “R-2022-0795” of the City Of West Allis
Municipal Resolutions is hereby *added* as follows:

ADOPTION

R-2022-0795(*Added*)

PASSED AND ADOPTED BY THE CITY OF WEST ALLIS COUNCIL

_____.

	AYE	NAY	ABSENT	ABSTAIN
Ald. Vince Vitale	_____	_____	_____	_____
Ald. Tracy Stefanski	_____	_____	_____	_____
Ald. Marty Weigel	_____	_____	_____	_____
Ald. Suzzette Grisham	_____	_____	_____	_____
Ald. Danna Kuehn	_____	_____	_____	_____
Ald. Thomas Lajsic	_____	_____	_____	_____
Ald. Dan Roadt	_____	_____	_____	_____
Ald. Rosalie Reinke	_____	_____	_____	_____
Ald. Kevin Haass	_____	_____	_____	_____

Attest

Presiding Officer

Rebecca Grill, City Clerk, City Of
West Allis

Dan Devine, Mayor, City Of West
Allis

MUNICIPAL SUPPORT AGREEMENT
between
City of West Allis
and
Midwest BikeShare, Inc. d/b/a Bublr Bikes

This License Agreement (“**Agreement**”) is made by and between the City of West Allis (“**West Allis**”), a municipal corporation and Midwest BikeShare, Inc. d/b/a Bublr Bikes (“**Bublr**”) and is effective November _____, 2022 (the “**Effective Date**”).

RECITALS

WHEREAS West Allis seeks to maintain the operation of the Bublr System in West Allis inclusive of electric assist bicycles.

WHEREAS Bublr seeks to maintain best-in-class bikeshare operations.

WHEREAS, Bublr shall maintain eight (8) working docking stations within the City of West Allis.

NOW, THEREFORE, for the good and valuable consideration set forth herein, Bublr and West Allis agree as follows:

1. **Term.** This Agreement shall cover 2022 and 2023. Thereafter, this Agreement may be renewed or extended by mutual written agreement of the Parties.
2. **Payment.** West Allis will pay Bublr \$32,000.
3. **Services.**
 - a. **Operations.** Bublr will generally operate the Bublr Bikeshare System in West Allis as outlined in the attached “Operating Agreement – Explanation of Services” incorporated into this agreement by reference.
 - b. **Station Number and Size.** Bublr will maintain the number and size of all stations located in West Allis for the duration of this agreement.
 - c. **Electric Assist Bicycles.** Bublr will maintain electric assist bicycles in the West Allis subsystem
 - d. **Customer Service.** Bublr will provide live, U.S. based customer service during the West Allis Operating Season
 - e. **Service Season.** Bublr will ensure that the West Allis subsystem is operational for a minimum of eight (8) months each calendar year.
- f. **Data.** Bublr shall report on the ridership and share the information with Common Council.
4. **Pass Discount.** Bublr will provide a six (6) Annual Passes to the City of West Allis to utilize in marketing and promotions.

5. **Liability.**
 - a. **Bubl's Waiver.** Bubl waives all rights to bring a claim against West Allis officers, employees or agents, for property damage and economic loss Bubl suffers, which claims arise from, or are related to, this Agreement.
 - b. **West Allis's Waiver.** West Allis will indemnify and hold harmless Bubl, all its officers, agents, and employees, from and against any and all losses, claims, damages, expenses and suits arising from West Allis's negligence or willful misconduct in the installation or other operation of the bikeshare equipment covered by this Agreement.
 - c. **Third-Party Liability.** This Agreement does not create or confer any rights, benefits, or causes of action on, or to, any third-party.

6. **General Provisions.**
 - a. **Ownership of Equipment.** Each party shall remain the sole owner of equipment it purchased.
 - b. **Ownership of Brand.** Bubl shall remain the sole owner of the Bubl brand
 - c. **Changes, Modifications & Amendments.** This Agreement may only be changed, modified or amended in writing, signed by both Bubl and West Allis.
 - d. **Waiver.** The failure of Bubl or West Allis to enforce any portion of this Agreement does not operate as a waiver. No portion of this Agreement will be deemed waived unless such waiver is explicitly made in writing and signed by both Parties.
 - e. **Construction & Severability.** Wherever possible, each provision of this Agreement will be interpreted so that it is valid under the applicable law. If any provision of this Agreement is held to be void, voidable or otherwise unenforceable by a court of competent jurisdiction, such a provision will still be effective to the extent it remains valid. Any provision held to be completely invalid shall be severed from this Agreement. In either case, all other provisions shall remain valid to the maximum extent allowable by law.
 - f. **Counterparts.** This Agreement may be executed in any number of counterparts, which may be transmitted electronically. Each executed counterpart, whether delivered in the original or conveyed as an electronic image, shall be deemed to be an original. All executed counterparts taken together shall constitute one agreement.
 - g. **Merger Clause.** This Agreement, and all exhibits, represent the entire agreement between Bubl and West Allis with respect to the subject matter hereof, and all prior agreements and understandings with respect to such subject matter are superseded by this Agreement
 - h. **Controlling Law.** This Agreement shall be governed by, construed and incorporated in accordance with the laws of the State of Wisconsin.

7. **Notices.** Notices provided for in this Agreement, must be given in writing and may be delivered in person or by placing such notice in the United States mail, first class and certified, return receipt requested, postage paid and addressed as follows:

If to Bublr: Bublr Bikes
PO Box 235
Milwaukee, WI 53201
Attention: James Davies, Executive Director
Email: james@bublrbikes.org

If to West Allis:

City of West Allis
West Allis City Hall
c/o Planning and Zoning
7525 W. Greenfield Avenue
West Allis, WI 53214
Attention: Steve Schaer, Manager of Planning and Zoning
Email: sschaer@westalliswi.gov

Midwest BikeShare, Inc. and West Allis have executed this License Agreement as of the Effective Date.

Midwest BikeShare, Inc., a Wisconsin Nonprofit

By: James Davies
Its: Executive Director

The City of West Allis

By: Steve Schaer
Its: Manager of Planning and Zoning

**CITY OF WEST ALLIS
RESOLUTION R-2022-0788**

**RESOLUTION APPROVING A RATE CHANGE IN THE 2023 SANITARY SEWER
USAGE CHARGE – CITY PORTION**

WHEREAS, Section 1.07(4)(e) authorizes the Common Council to revise sanitary sewer user charges, as necessary, to insure that the system generates adequate revenues to pay the cost of operation and maintenance, including replacement of the Sanitary Sewer Collection System; and,

WHEREAS, the sanitary sewer rates were last changed January 1, 2018, when Resolution R-2017-0353 increased the rate \$0.20 to the current rate of \$1.95 per CCF; and,

WHEREAS, the 2023 proposed budget requires an increase in the sanitary sewer user charge to pay the cost of sanitary sewer operations and maintenance.

NOW THEREFORE, BE IT RESOLVED by the Common Council of the City of West Allis that there be a 2023 increase in the rates for the sanitary sewer user charge - city portion, and is hereby changed to \$2.15 per CCF of water used per quarter from \$1.95 per CCF of water used per quarter (an increase of \$0.20 per CCF), with the minimum quarterly charge increased to \$21.50 per quarter from \$19.50 per quarter (an increase of \$2.00 per quarter) effective January 1, 2023.

BE IT FURTHER RESOLVED that Utility Billing Staff be and is hereby directed to notify each user of the Sanitary Sewer Collection System of the aforesaid rate increase as provided in Section 1.07(4)(f) of the Revised Municipal Code.

SECTION 1: **ADOPTION** “R-2022-0788” of the City Of West Allis Municipal Resolutions is hereby *added* as follows:

ADOPTION

R-2022-0788(*Added*)

PASSED AND ADOPTED BY THE CITY OF WEST ALLIS COUNCIL

_____.

	AYE	NAY	ABSENT	ABSTAIN
Ald. Vince Vitale	_____	_____	_____	_____
Ald. Tracy Stefanski	_____	_____	_____	_____
Ald. Marty Weigel	_____	_____	_____	_____
Ald. Suzzette Grisham	_____	_____	_____	_____
Ald. Danna Kuehn	_____	_____	_____	_____
Ald. Thomas Lajsic	_____	_____	_____	_____
Ald. Dan Roadt	_____	_____	_____	_____
Ald. Rosalie Reinke	_____	_____	_____	_____
Ald. Kevin Haass	_____	_____	_____	_____

Attest

Presiding Officer

Rebecca Grill, City Clerk, City Of
West Allis

Dan Devine, Mayor, City Of West
Allis

**CITY OF WEST ALLIS
RESOLUTION R-2022-0789**

**RESOLUTION APPROVING AN INCREASE IN THE SOLID WASTE FUND USER
CHARGE**

WHEREAS, Section 15.03 authorizes the Common Council to revise the solid waste user charges necessary to insure that the system generates adequate revenue to pay the cost of operation and maintenance; and,

WHEREAS, the solid waste rates were last changed January 1, 2022, when Resolution R-2021-0827 increased the Class I quarterly rate \$5.30 to the current rate of \$27.80 per RU, and increased the Class II quarterly rate \$0.35 to the current rate of \$11.40 per RU; and,

WHEREAS, due to the significant increase in dumping fees, the 2023 proposed budget requires an increase in the solid waste user charge to adequately fund the cost of solid waste operations and maintenance; and,

WHEREAS, Customer Class 1 solid waste users are single family residential units and Customer Class 2 solid waste users are four family residential units. Customer Class 2 solid waste users receive only recycling service.

NOW THEREFORE, BE IT RESOLVED by the Common Council of the City of West Allis that an increase of \$7.86 in the quarterly Customer Class 1 solid waste user charge from \$27.80 in 2022 per residential unit to \$35.66 in 2023 per residential unit and an increase of \$1.18 in the quarterly Customer Class 2 solid waste user charge from \$11.40 in 2022 per residential unit to \$12.58 to 2023 per residential unit, be and is hereby approved, said increase to be effective January 1, 2023.

BE IT FURTHER RESOLVED that Utility Billing Staff be and are hereby directed to notify each user of the Solid Waste Collection of the aforesaid rate increase as provided in Section 1.07(4)(f) of the Revised Municipal Code.

SECTION 1: **ADOPTION** “R-2022-0789” of the City Of West Allis Municipal Resolutions is hereby *added* as follows:

ADOPTION

R-2022-0789(*Added*)

PASSED AND ADOPTED BY THE CITY OF WEST ALLIS COUNCIL

_____.

	AYE	NAY	ABSENT	ABSTAIN
Ald. Vince Vitale	_____	_____	_____	_____
Ald. Tracy Stefanski	_____	_____	_____	_____
Ald. Marty Weigel	_____	_____	_____	_____
Ald. Suzzette Grisham	_____	_____	_____	_____
Ald. Danna Kuehn	_____	_____	_____	_____
Ald. Thomas Lajsic	_____	_____	_____	_____
Ald. Dan Roadt	_____	_____	_____	_____
Ald. Rosalie Reinke	_____	_____	_____	_____
Ald. Kevin Haass	_____	_____	_____	_____

Attest

Presiding Officer

Rebecca Grill, City Clerk, City Of
West Allis

Dan Devine, Mayor, City Of West
Allis



City of West Allis
Meeting Minutes
Administration and Finance Committee

Aldersperson Kevin Haass, Chair
Aldersperson Danna Kuehn, Vice-Chair
Alderspersons: Thomas G. Lajsic, Angelito Tenorio, and Martin J. Weigel

Monday, October 17, 2022

6:00 PM

City Hall, Room 128
7525 W. Greenfield Ave.

REGULAR MEETING

A. CALL TO ORDER

Ald. Reinke called the meeting to order at 6:00 p.m.

B. ROLL CALL

Present 5 - Ald. Haass, Ald. Kuehn, Ald. Lajsic, Ald. Tenorio, and Ald. Weigel

C. MATTERS FOR DISCUSSION/ACTION

1. [2022-1002](#) 2023 City of West Allis Mayor's Recommended Budget.

Mayor Devine, Finance Director Kaczmarek, and City Administrator Grill presented information on the Mayor's 2023 Recommended Budget.

Discussion Purposes Only

D. ADJOURNMENT

Ald. Lajsic moved to adjourn at 6:46 p.m., Ald. Weigel seconded, motion carried.



All meetings of the {bdName} are public meetings. In order for the general public to make comments at the committee meetings, the individual(s) must be scheduled (as an appearance) with the chair of the committee or the appropriate staff contact; otherwise, the meeting of the committee is a working session for the committee itself, and discussion by those in attendance is limited to committee members, the mayor, other alderpersons, staff and others that may be a party to the matter being discussed.

NON-DISCRIMINATION STATEMENT

The City of West Allis does not discriminate against individuals on the basis of race, color, religion, age, marital or veterans' status, sex, national origin, disability or any other legally protected status in the admission or access to, or treatment or employment in, its services, programs or activities.

AMERICANS WITH DISABILITIES ACT NOTICE

Upon reasonable notice the City will furnish appropriate auxiliary aids and services when necessary to afford individuals with disabilities an equal opportunity to participate in and to enjoy the benefits of a service, program or activity provided by the City.

LIMITED ENGLISH PROFICIENCY STATEMENT

It is the policy of the City of West Allis to provide language access services to populations of persons with Limited English Proficiency (LEP) who are eligible to be served or likely to be directly affected by our programs. Such services will be focused on providing meaningful access to our programs, services and/or benefits.



BUDGET & ACTION PLAN

As recommended by Mayor Dan Devine

**Public Hearing
November 1, 2022**

3
2
0
2

Vision Statement

West Allis will become the preferred city for visitors, residents, and businesses.

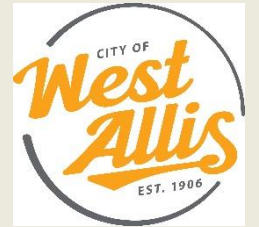

Mission Statement

The City of West Allis exists to provide:

- cost effective municipal services consistent with the needs and desires of the citizens of the West Allis community (residences and businesses, as well as other community stakeholders)
- for the health, safety, and welfare of the community
- a quality living and working environment
- a positive, progressive, and creative approach to the budget, management, and operations of the City.

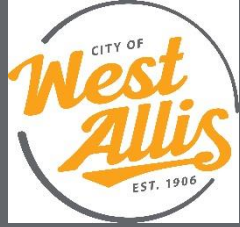

Demographics

60,068

Population
Estimate

52.3%

Owner Occupied
Housing Units

\$148,400

Median Value of
Owner Occupied
Housing

\$53,634

Median Household
Income (2020 \$)

11.2%

Persons in Poverty

15.6%

Persons over 65

<https://www.census.gov/quickfacts/westalliscitywisconsin>

2022-2026 STRATEGIC PLAN FOCUS AREAS

1. Community – A community that is healthy, accessible, attractive, and open to all community members and visitors.
2. Destination – A community that attracts business, engages in partnerships, and is considered a safe and attractive place to live, work, and visit.
3. Financial – An organization that is fiscally responsible and aligns organizational resources with the needs of the community.
4. Infrastructure – A long-term approach to investing in, managing, and maintaining, the City’s physical assets.
5. Organizational Excellence – An organization that makes investments in employees and is accountable and transparent in its practices.

2023 Recommended Budget Priorities

Neighborhood Initiatives

- Neighborhood Associations activities and additional established
- Liberty Heights Pavilion Design (CDBG funding)
- Nuisance Abatement Program
- Continue with pest control measures (\$10,000 in CDBG budget)
- Pilot sterilization product in use in other municipalities (\$2,000 in Health budget)
- Employ summary abatement ordinance passed by Common Council to immediately abate harborages in eligible cases
- Continued City-wide staff focus on rodent abatement plan

Public Safety Resources and Strategies

- Expand Flock Cameras from a pilot program to a long-term strategy in the reduction of crime and reckless driving, we currently have numerous alerts per week, many resulting in arrests for stolen vehicles and other criminal activity (Additional \$25,000 in Police budget)
- Add funding for additional staff in parking enforcement (Additional \$25,000 in Police budget, offset by increased revenue estimate of \$25,000)
- Expand Axon Product contract to increase safety and efficiency for officers and administrative staff

Challenges

**Severely
Restricted**

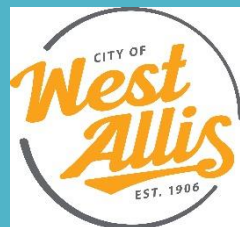

- **State Funding Structure for Wisconsin Municipalities**
 - **Overreliance on Property Taxes**
 - **Stagnant/Reduced State Aids**
 - **Expenditure Restraint Program**
 - **Levy Limits**
- Public Safety Budget Growth
- Aging Infrastructure
 - Street Light Conversion Project
 - Facility Repairs and Maintenance
- Recruiting and Retention of High-Quality Employees
- Taxpayer Financial Limitations

Overreliance on Property Taxes

No Options

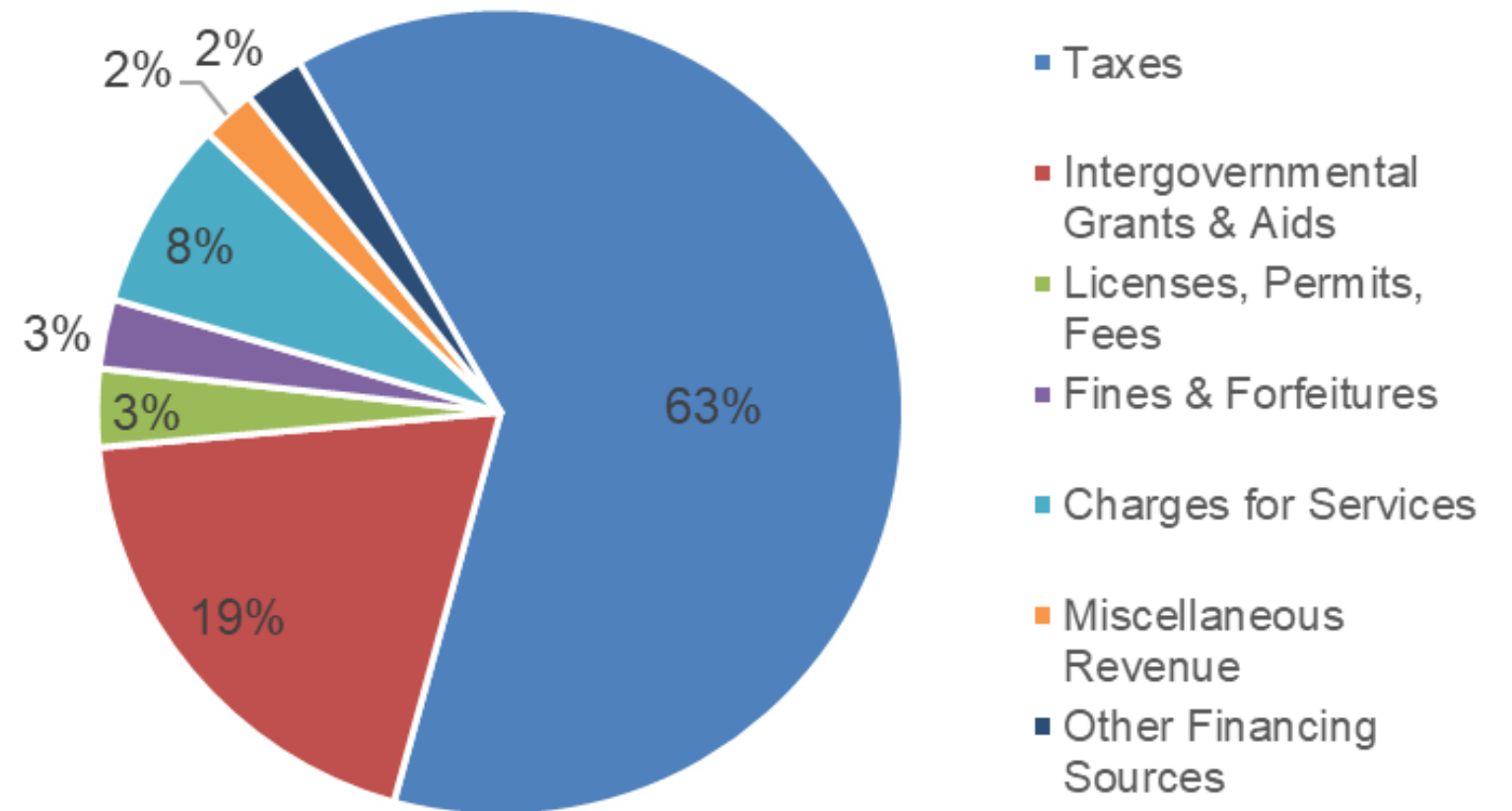

Budgeted Revenues

State Aids Remain Flat

Handcuffed

How much?

Through various programs, the State is expected contribute **\$12.2 million** to the City in 2023.

Did it offset cost increases?

Overall, the City will receive a 0% increase in State Aid, so **No**, it's not helping to cover normal cost increases.

Does it matter?

Yes! State Aid accounts for 18% of the City's General Fund budget. Even a modest 2% increase in this funding would have doubled the impact we're getting from the local tax levy.



Levy Limits

**Severely
Restricted**

What are levy limits?

Levy Limits provide prohibit county, city, villages or towns from increasing their base levy by more than the percentage change of net new construction, between the previous year and the current year.

What is net new construction?

Net new construction/demolition of buildings and land improvements

Includes Tax Increment District (TID) activity

Value is compared to total equalized value to calculate a percentage change

What is the penalty for exceeding the levy limit?

The penalty is a dollar-for-dollar loss of shared revenue. **Ex.:** If a municipality exceeds its levy limit by \$1,000, its state shared revenue payment is reduced by \$1,000.



2005 - Enacted in 2005 for 2006 levies to slow local property tax increases

Linked to net new construction, but a floor of 2% was established

2006 to 2010 - Levy Limit Floor varied between 2% and 3.86%; this allowed fully developed and slow growth communities to be protected in the event their net new construction was low

2011 - Law was changed so that any levy increase was limited to property values of net new construction and the floor was lowered to 0%; fully developed and slow growth communities lost protection of the minimum increases

History of Levy Limits

Expenditure Restraint Program (ERP)

What is it? Aid provided by State to municipalities who limit growth in spending.

How is it calculated? For the year prior to the aid payment, the rate of the budget growth cannot exceed the inflation rate plus an adjustment based on the growth in municipal property values.

What is the aid amount we get if we remain within the limit? ~\$1.6 million per year (or less than 3% of our annual budget)

What has been the average ERP limit in past 7 years? 2.1% (2016 increase was one of the lowest at ~\$400,000) (Ignores 2022 at 8.1%)





1990 - Established due to the way state aid was determined; aid was allocated based on spending; increases in spending were encouraged so more aid was received



1994 - Qualified tax rate was changed to 5 mills and limit was changed to GF



Funding set at \$42 million for program with 240 towns, villages, and cities participating



2003 - Funding was changed to \$58,145,700 for 319 towns, villages and cities who participate



2020 - Funding has remained at 2003 levels



History of ERP

Year	State Shared Revenue	Expenditure Restraint Aid	Exempt Computer Aid	Municipal Services Payment	Transportation Aids	Total State Aid*
2001	\$9,339,990	\$1,693,278	\$313,281	\$258,232	\$2,422,416	\$14,027,197
2002	9,431,527	1,604,472	249,810	262,900	2,304,919	13,853,628
2003	9,518,429	1,751,835	213,623	337,368	2,191,504	14,012,759
2004	8,519,543	1,811,626	184,269	289,909	2,084,706	12,890,053
2005	8,532,789	1,788,771	169,472	266,846	2,029,692	12,787,570
2006	8,521,008	1,876,354	160,032	273,573	2,112,518	12,943,485
2007	8,514,956	1,875,045	174,715	268,953	2,179,504	13,013,173
2008	8,545,104	1,845,041	159,683	202,725	2,245,132	12,997,685
2009	8,590,825	1,756,743	200,994	202,728	2,316,363	13,067,653
2010	8,250,368	1,636,156	195,595	201,506	2,418,692	12,702,317
2011	8,302,417	1,615,560	186,079	209,144	2,533,566	12,846,766
2012	7,228,751	1,627,054	187,843	8,039	2,287,195	11,338,882
2013	7,271,168	1,609,640	177,455	8,342	2,241,407	11,308,012
2014	7,268,863	1,548,237	177,631	8,314	2,208,565	11,211,610
2015	7,181,455	1,621,354	206,182	8,767	2,336,369	11,354,127
2016	7,184,998	1,574,913	189,550	202,510	2,259,021	11,410,992
2017	7,297,983	1,498,668	175,071	188,492	2,248,523	11,408,737
2018	7,294,641	1,519,285	177,645	199,511	2,482,335	11,673,417
2019	7,293,027	1,532,604	181,944	213,890	2,357,433	11,578,898
2020	7,322,570	1,547,479	181,944	192,894	2,558,757	11,803,644
2021	7,338,553	1,589,006	181,944	224,678	2,570,788	11,904,969

History of State Aids

*Does not include Personal Property Aid which has a net zero revenue effect during these years

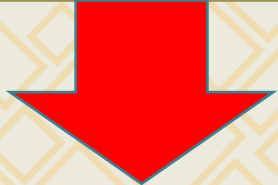
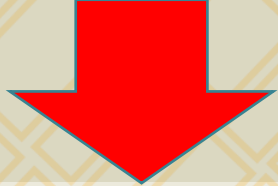
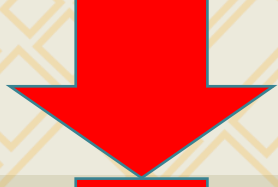
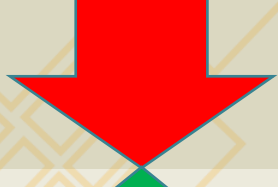

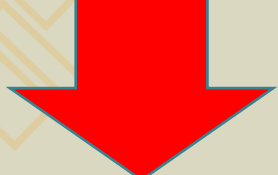
Shared Revenue	\$(2,001,437)	
Expenditure Restraint	\$(104,272)	
Exempt Computer Equip.	\$(131,337)	
Municipal Services Payment	\$(33,554)	
Transportation Aids	\$148,372	
Overall	\$(2,122,228)	

Change over 20 years of State Aids

Shared Revenue Changes



Expenditures by Department

- General Government
- Public Safety
- Public Works
- Health & Human Services
- Culture & Recreation
- Conservation & Development

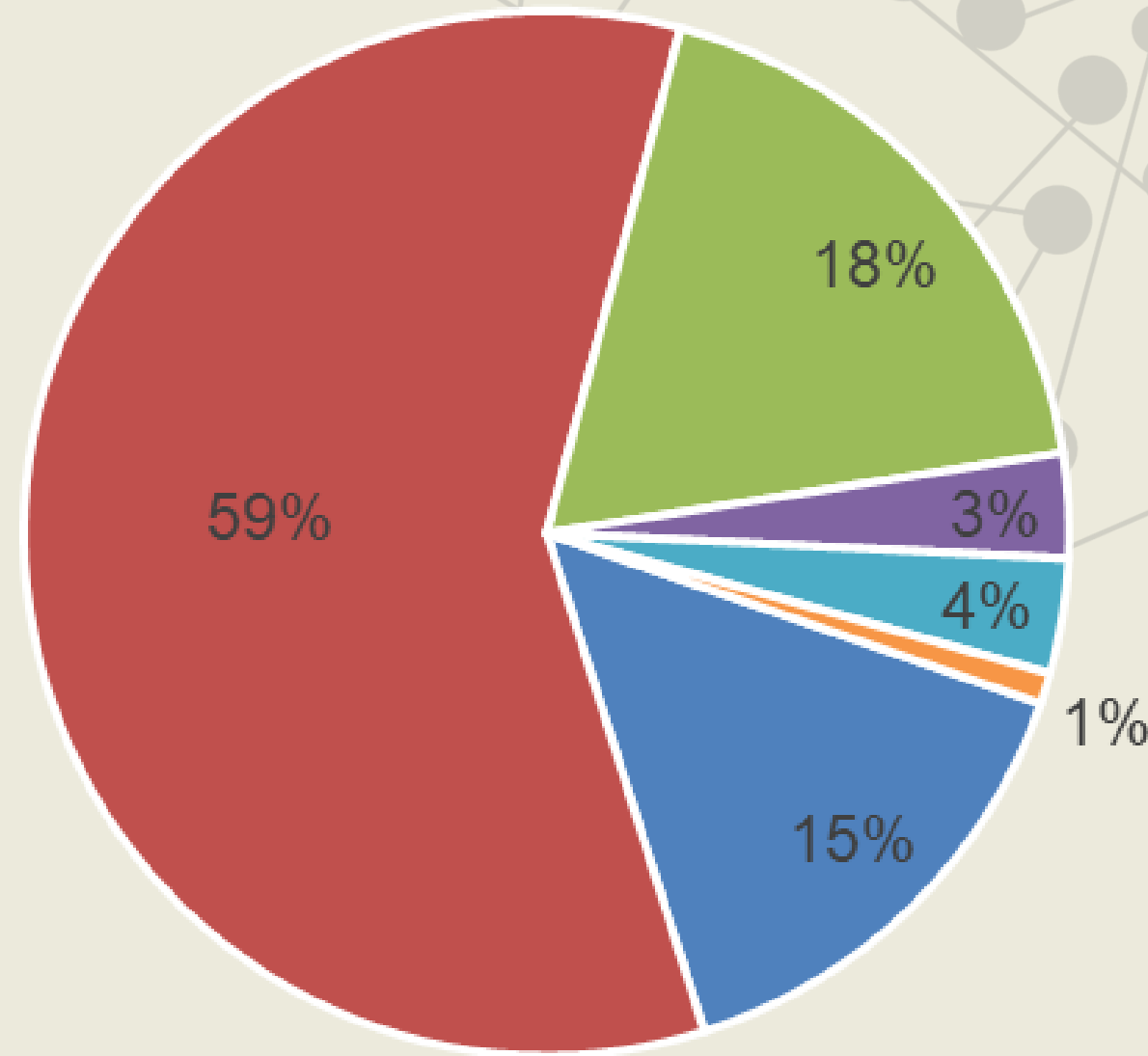

Budgeted Expenditures

Personnel

538.65

BENEFITTED POSITIONS

DOWN FROM 544.65 IN 2022



492.65

GENERAL FUND
POSITIONS

51.00

FUNDED BY OTHER
FUNDING
SOURCES

Department	2017	2023*	Change
Benefitted Positions – City Wide	580.15	538.28	(41.87)
Police	160.55	160.15	(0.4)
Fire	106.00	106.00	-0-
Public Works	144.5	116	(28.5)
Health	39.55	36.28	(3.27)

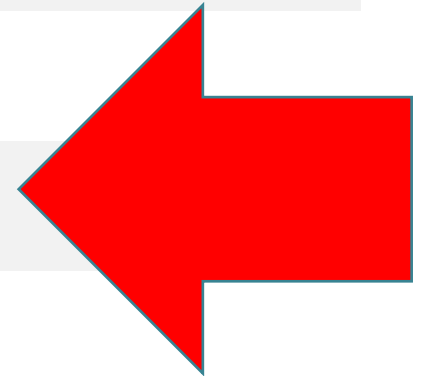

Personnel 2017 v 2023



**Personnel Costs
81% of General
Fund Budget**

\$55,088,630

WRS Contributions

Employee Type	Employee Contribution	West Allis Contribution	Est. Annual City Contribution for employee making \$65K
General Employees	6.8%	6.8%	\$4,420
Police	6.8%	13.2%	\$8,580
Fire	6.8%	18.1%	\$7,735*

* Net of Social Security savings of 6.2%

Department	2023
General Government	\$ 362,544
Police	\$1,237,738
Fire	\$1,061,057
Public Works	\$ 792,145
Health	\$ 63,378

Current Retiree Benefit Costs (Health Insurance – OPEB)



All of the challenges result in a gap between requests and allowable increases as well as an ongoing structural deficit

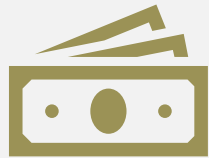

For the 2023 Budget – the levy increase to our GF budget, where most of our operating costs are was limited to **\$215,000**



We had an estimated *\$1.3 million* gap between what the allowable levy increase and the 2023 budget requests

**Budget Gap
for 2023 -
~\$1,300,000**

Closing the Budget Gap for 2023 – One time Solutions

Increased Revenues

- Levy Limit Allowance \$215,000
- Ambulance Charges – (Medicaid reimbursements doubled) \$660,000
- Increased Interest Earnings \$350,000
- Additional parking revenue (offset by increased staffing costs) \$25,000

Health Insurance

- Estimated 0% increase for 2023

Position Changes

- Details on following slide



Recommended Position Changes

Assessor – move one Code Enforcement administrative position to Assessor’s Office (department request was a new position, this reallocation does not increase number of positions)

Code Enforcement - move administrative position to Assessor’s Office as listed above; move Zoning Administrator position from Planning and Zoning to Code Enforcement for continued focus on nuisance enforcement activities

Fire – Deputy Chief positions in MIH and Training Bureau change to Captains

Planning and Zoning – move Zoning Administrator to Code Enforcement

Police - Elimination of 1 Administrative position in the Police Department to fund the market adjustments of Dispatchers’ salaries; Additional funding for parking enforcement

Public Works – adjust yard attendant to Truck Driver position for more flexibility; eliminate HVAC Technician; eliminate Inventory Services Specialist; eliminate 3 Maintenance Repairers – one in Sanitation and Streets, two in Water



Department Changes in 2023 Recommended Budget

IT Budget –

Decrease in Maintenance Contracts due to transfer of software maintenance/support contracts to business units

(i.e. ERP & Payroll software costs moved to Finance, Licensing & Permitting software costs moved to City Clerk, Asset Management/Work Order software costs moved to DPW, etc).

\$327,500 decrease is not an overall budget reduction; these amounts will appear as increases in the affected department budgets.

Finance –

Salary & Fringe increase reflects salaries budgeted at gross, rather than net of charge out to utility funds. Increase is offset by a corresponding inter-departmental revenue from the utilities so no net budget impact and improved transparency. Increase in Maintenance Contracts reflects the transfer of software maintenance contracts for payroll and accounting software from the IT budget. No net impact due to corresponding decrease in IT budget.

Summary of Department Changes Continued

Clerk

Increase in maintenance contracts due to license and permitting software costs being transferred from IT budget.

Police

- Salary expense includes an estimate for a contractual increase in pay/benefits and the related compression pay for non-represented employees.
- Salary expense also reflects a market increase to Dispatcher salaries.
- Pension increase due to an increase to the WRS required contribution rate
- The Increase in maintenance contracts reflects the cost of software maintenance being transferred from IT budget, as well as additional software.
- A mayor-proposed \$25,000 addition to salaries is included to fund additional parking enforcement efforts, offset by an anticipated revenue increase in parking permits/fines.
- A mayor-proposed \$25,000 increase to expand the use of Flock Cameras has been included based on results in reducing crime and reckless driving from a recent pilot program.



Summary of Department Changes Continued

Fire

- Salary expense includes an estimate for a contractual increase in pay/benefits and the related compression pay for non-represented employees.
- Three vacant firefighter positions remain unfunded for 2023.
- Salaries includes a reduction for grant funding for Mobile Integrated Health (MIH) services.
- Pension expense increase is due to the increased WRS required contribution rate
- "Retiree Benefits" expense item reflects the city-funded portion of health insurance premiums for retirees of the Fire Department.



Summary of Department Changes Continued

Health

Salary & Benefit changes reflect several recent position changes, consolidations, eliminations and a temporary budget reduction in the General Fund Health Department based on COVID response grant funding anticipated for a portion of 2022.

Salaries & Benefits for staff working on grant funded COVID response are charged to a separate Health Grants Fund.

A portion of the above increase reflects the impact of temporary COVID funding phasing out.

Note: The "Retiree Benefits" expense item reflects the city-funded portion of health insurance premiums for retirees of the Health Department.



Summary of Department Changes Continued

Library

Salary & Benefit changes reflect a net reduction in mostly, part-time staffing.

Note: The "Retiree Benefits" expense item reflects the city-funded portion of health insurance premiums for retirees of the Library.

Public Works

Salary increases are the result of standard salary progression/performance pay increases, as well as market adjustments for Truck Drivers, Maintenance Repairers, Mechanics, and others as needed to compete for staff in a tight labor market. The department also eliminated three positions (HVAC Tech, Inventory Specialist, Maintenance Repairer).

Note: The "Retiree Benefits" expense item reflects the city-funded portion of health insurance premiums for retirees of DPW.



Summary of Changes Continued

Engineering

Salary & Benefit decreases reflect additional Engineering staff time billed to Water, Sanitary Sewer, and Storm Water for design and construction management of utility construction projects.

Promotions

Salary increases are the result of increased funding for part-time market attendant positions for events at the Farmer's Market.

Communications

Communications has been merged into the general fund for 2023 from a special revenue fund. The reason for this change is due franchise fee changes. Impact is minimal due to the revenue from the account also being transferred.



General Fund Revenues

Taxes	\$42,370,000
Intergovernmental Grants & Aids	\$13,094,000
Licenses, Permits and Fees	\$2,114,100
Fines and Forfeitures	\$1,881,000
Charges for Services	\$5,133,900
Miscellaneous	\$3,093,000

General Fund Expenditures

Category	2023 Amount	Change from 2022
General Government	\$10,046,344	+2.1%*
Public Safety	\$39,942,526	+4.7%
Public Works	\$12,457,403	+1.3%
Health & Human Services	\$2,192,315	+8.9%**
Culture & Recreation	\$2,401,728	-0.4%
Conservation & Development	\$645,684	+1.8%

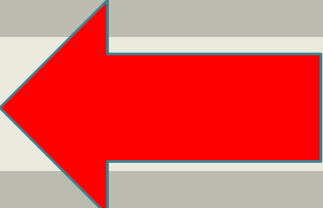

*increase from moving Communications to General Fund; change is net of benefit allocations to non-general categories

**increases due to regular employees that were allocated to COVID funds, salaries returned to general fund to maintain capacity

Historical/Background Information

Equalized Value

- 2022 - \$5,518,411,300
- 2021 - \$4,780,305,200
- 2020 - \$4,324,118,600
- 2019 - \$4,010,376,800
- 2018 - \$3,820,597,600
- 2017 - \$3,722,361,000

Overall Tax Rate

- 2022 - \$28.05 (est.)
- 2021 - \$27.72
- 2020 - \$27.90
- 2019 - \$27.16
- 2018 - \$27.48
- 2017 - \$28.28

Assessed Value

- 2022 - \$3,961,529,200 (est.)
- 2021 - \$3,953,572,200
- 2020 - \$3,918,312,400
- 2019 - \$3,882,330,800
- 2018 - \$3,710,465,900
- 2017 - \$3,751,889,600

General Fund Revenue

- 2022 - \$65,344,524
- 2021 - \$66,051,114
- 2020 - \$64,643,000
- 2019 - \$63,243,000
- 2018 - \$62,505,716
- 2017 - \$61,170,867

Local Tax Rate

- 2022 - \$12.12 (est.)
- 2021 - \$12.02
- 2020 - \$11.91
- 2019 - \$11.56
- 2018 - \$11.53
- 2017 - \$11.26

General Fund Expenditures

- 2022 - \$65,344,524
- 2021 - \$66,051,114
- 2020 - \$64,643,000
- 2019 - \$63,243,000
- 2018 - \$62,505,716
- 2017 - \$61,170,867



**Estimated City Tax based
on \$150K Home**

\$1,818

INCREASE OF \$15

Sanitary and solid waste average increase of \$50

- ~~Obtain final assessment information from state~~
- ~~Calculate final City tax rate~~
- Provide additional information as needed
- Council consideration of Recommended Budget on November 15

Next Steps



Warning

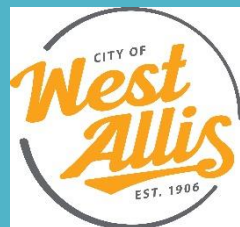

State Funding Structure for Wisconsin Municipalities is unsustainable.

Unless there is a change to this model, departments that have continued increases to budget will require reduction of staff/services to meet financial limitations.

**What questions
do you have?**



PROOF OF PUBLICATION

STATE OF WISCONSIN }
MILWAUKEE COUNTY } s.s.

Joe Yovino, being the first duly sworn on oath, says that he or she is the Associate Publisher/Editor of THE DAILY REPORTER, which is a public newspaper of general circulation, printed and published daily in the English language in the City of Milwaukee, in said county, and fully complying with the laws of Wisconsin, relating to the publication of legal notices; that the notice of which the printed one attached is a true copy, which was clipped from the said newspaper, was inserted and published in said newspaper on

Oct. 17, 2022

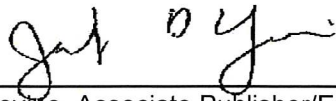

Joe Yovino, Associate Publisher/Editor

Sworn to me this 17th day of October 2022



Russell A. Klingaman
Notary Public, Milwaukee County, Wisconsin
My Commission Is Permanent

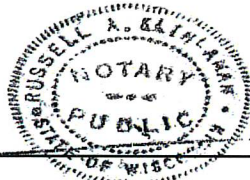

PROOF OF PUBLICATION

AFFIDAVIT OF PUBLICATION

CITY OF WEST ALLIS, WISCONSIN
NOTICE OF PUBLIC HEARING - 2023 PROPOSED BUDGET
 WEST ALLIS CITY HALL, 7525 W GREENFIELD AVENUE, WEST ALLIS, WI

NOTICE IS HEREBY GIVEN, in accordance with Section 65.90(3) Wisconsin Statutes, that a Public Hearing will be held on Tuesday, November 1, 2022 at 7:00 PM or shortly thereafter on the proposed City of West Allis Budget for the year 2023, as recommended by the Mayor. Any resident or taxpayer shall have the opportunity to be heard thereon. A summary of the Proposed Budget is shown below and a copy of the complete proposed Budget is available for public inspection at the West Allis City Hall and the West Allis Public Library during normal business hours.

GENERAL FUND *****	2021 ACTUAL	2022 ESTIMATED	2022 BUDGET	2023 PROPOSED	%
FUND BALANCE, JANUARY 1	\$ 44,814,369	\$ 44,906,592	\$ 44,906,592	\$ 49,047,685	CHANGE
EXPENDITURES					
General Government	\$ 13,694,067	\$ 9,009,479	\$ 9,841,867	\$ 10,046,344	2.1%
Public Safety	34,197,920	38,037,438	38,148,113	39,942,526	4.7%
Public Works	10,642,758	11,094,735	12,297,112	12,457,403	1.3%
Health & Human Services	1,777,145	1,843,895	2,012,560	2,192,315	8.9%
Culture & Recreation	2,465,764	2,185,913	2,410,805	2,401,728	(0.4%)
Conservation & Development	570,123	492,383	634,067	645,684	1.8%
TOTAL EXPENDITURES	\$ 63,347,777	\$ 62,663,843	\$ 65,344,524	\$ 67,686,000	3.6%
REVENUES					
Taxes (other than property)	\$ 1,883,970	\$ 1,716,800	\$ 1,806,504	\$ 1,667,426	(7.7%)
Intergovernmental Grants & Aids	12,912,973	12,960,600	12,882,918	13,094,000	1.6%
Licenses, Permits, Fees	1,940,078	2,055,300	1,727,825	2,114,100	22.4%
Fines & Forfeitures	1,636,485	1,788,200	1,808,174	1,881,000	4.0%
Charges for Services	4,547,318	4,517,736	3,978,350	5,133,900	29.0%
Miscellaneous Revenues	860,446	1,813,800	1,044,000	1,463,500	40.2%
Other Financing Sources	1,671,589	1,619,500	1,649,498	1,629,500	(1.2%)
TOTAL REVENUES	\$ 25,452,859	\$ 26,471,936	\$ 24,897,269	\$ 26,983,426	8.4%
PROPERTY TAX	37,987,141	40,333,000	40,447,255	40,702,574	0.6%
FUND BALANCE, DECEMBER 31	\$ 44,906,592	\$ 49,047,685	\$ 44,906,592	\$ 49,047,685	

ALL FUNDS *****	GENERAL	DEBT SERVICE	ENTERPRISE
Tax Levy	\$ 40,702,574	\$ 4,451,831	\$ -
Other Revenues	26,983,426	-	25,662,650
Total Revenue	67,686,000	4,451,831	25,662,650
Expenditures	(67,686,000)	(4,467,600)	(23,218,860)
Revenue over/(under) Expenditures	-	(15,769)	2,443,790
Estimated Fund Balance, January 1	49,047,685	278,640	112,440,260
Fund Balance, December 31	\$ 49,047,685	\$ 262,871	\$114,884,050
	INTERNAL SERVICE	ALL OTHER GOV FUNDS	SUMMARY ALL FUNDS
Tax Levy	\$ -	\$ -	\$ 45,154,405
TIF Tax Levy	-	6,922,788	6,922,788
Other Revenues	16,323,125	34,174,026	103,143,227
Total Revenue	16,323,125	41,096,814	155,220,420
Expenditures	(16,205,810)	(36,257,031)	(147,835,301)
Revenue over/(under) Expenditures	117,315	4,839,783	7,385,119
Estimated Fund Balance, January 1	10,820,641	31,049,142	203,636,368
Fund Balance, December 31	\$ 10,937,956	\$ 35,888,925	\$211,021,487

There are no significant proposed increases or decreases to the current year budget due to new or discontinued activities or functions pursuant to 65.90(3)(bm), Wisconsin Statutes.

GENERAL OBLIGATION DEBT	12/31/2020	12/31/2021	12/31/2022
General Obligation Debt Outstanding	\$ 76,770,828	\$ 84,709,144	\$ 65,424,074

Dated at West Allis, Wisconsin
 this 13th day of October, 2022

Jason Kaczmarek
 Finance Director/Comptroller

PUBLISH: Monday, October 17th, 2022

CLASS 1 NOTICE

12165026/10-17

**CITY OF WEST ALLIS
ORDINANCE O-2022-0147**

**ORDINANCE APPROPRIATING THE NECESSARY FUNDS FOR THE
OPERATION AND ADMINISTRATION OF THE CITY OF WEST ALLIS FOR
CALENDAR YEAR 2023**

WHEREAS, the City of West Allis is required to adopt an annual budget pursuant to Wis. Stat. 65.90 and WAMC 1.04; and

WHEREAS, a public hearing on the proposed budget was held on November 1, 2022;

NOW THEREFORE, the common council of the City of West Allis do ordain as follows:

SECTION 1: **ADOPTION** “2023 Annual Budget” of the City Of West Allis Municipal Code is hereby *added* as follows:

ADOPTION

2023 Annual Budget(*Added*)

PART I. The amounts budgeted as General Fund Revenues and Expenditures shall be as noted in Attachment 1.

PART II. All other expenditures and revenues as outlined in the 2023 Common Council Adopted Budget are hereby appropriated and budgeted.

PART III. The amount levied for the year 2023 as a tax (exclusive of the TIF levy) upon all 2022 taxable property within the City of West Allis, as returned by the Assessor, for the uses and purposes set forth in the budget, presented herewith, shall be as follows:

General Fund	\$40,702,574
Debt Service Fund	\$4,451,831
Total Tax Levy	\$45,154,405

PART IV. The City Treasurer is authorized and directed to spread the said tax upon the current tax roll of the City of West Allis.

SECTION 2: **EFFECTIVE DATE** This Ordinance shall be in full force and effect on and after the required approval and publication according to law.

PASSED AND ADOPTED BY THE CITY OF WEST ALLIS COUNCIL

_____.

	AYE	NAY	ABSENT	ABSTAIN
Ald. Vince Vitale	_____	_____	_____	_____
Ald. Tracy Stefanski	_____	_____	_____	_____
Ald. Marty Weigel	_____	_____	_____	_____
Ald. Suzzette Grisham	_____	_____	_____	_____
Ald. Danna Kuehn	_____	_____	_____	_____
Ald. Thomas Lajsic	_____	_____	_____	_____
Ald. Dan Roadt	_____	_____	_____	_____
Ald. Rosalie Reinke	_____	_____	_____	_____
Ald. Kevin Haass	_____	_____	_____	_____

Attest

Presiding Officer

Rebecca Grill, City Clerk, City Of
West Allis

Dan Devine, Mayor, City Of West
Allis

**CITY OF WEST ALLIS
2023 GENERAL FUND BUDGET**

Revenues

Taxes	\$ 42,370,000
Intergovernmental Grants & Aids	13,094,000
Licenses, Permits, Fees	2,114,100
Fines & Forfeitures	1,881,000
Charges for Services	5,133,900
Miscellaneous Revenue	1,463,500
Transfers and Reserve Funds Applied	1,629,500

Total Revenues **\$ 67,686,000**

Expenditures

<u>General Government</u>	
Common Council	\$ 162,977
Mayor	123,395
City Attorney	901,672
Municipal Court	335,876
City Assessor	390,033
Administration	187,012
Information Technology	1,507,944
Human Resources	655,813
Finance	1,038,388
Treasurer	581,340
City Clerk	536,135
Promotion, Celebrations, Awards	170,766
Communications	713,824
Fringe Benefits	1,706,860
Other General Government	1,034,309
	10,046,344
<u>Public Safety</u>	
Police & Fire Commission	37,840
Police	23,297,624
Fire	15,320,538
Code Enforcement	1,286,524
	39,942,526
<u>Public Works</u>	
Engineering	1,092,315
Public Works	11,365,088
	12,457,403
<u>Health & Human Services</u>	
Health Department	2,192,315
	2,192,315
<u>Culture & Recreation</u>	
Senior Center	234,188
Library	2,167,540
	2,401,728
<u>Conservation & Development</u>	
Planning & Zoning	511,829
Economic Development	133,855
	645,684

Total Expenditures **\$ 67,686,000**

**CITY OF WEST ALLIS
RESOLUTION R-2022-0800**

**RESOLUTION GRANTING A PRIVILEGE TO WALTER HOLTZ FOR PROPERTY
LOCATED AT 7140-44 W. GREENFIELD AVE. (TAX KEY NO. 440-0310-000)**

WHEREAS, Walter Holtz requests from the City of West Allis a privilege to place an obstruction beyond a lot line within a highway as allowed by Wis. Stat. 66.0425, consisting of an ingress and egress ramp on the west side of the building and concrete steps and platforms with overhanging canopy or canopies on the north side of the building adjacent to the property located at 7140-7144 W. Greenfield Ave., in the City of West Allis, WI (“Privilege”); and

WHEREAS, by receiving this Privilege, the applicant assumes primary liability for damages to person or property by reason of the granting of this Privilege, is obligated to remove an obstruction or excavation upon 10 days' notice by the City and waives the right to contest in any manner the validity of this law or the amount of compensation charge; and

WHEREAS, the applicant will annually submit to the City proof of insurance consistent with coverage amounts required by the city attorney’s office; and

WHEREAS, the City requires the applicant to file a bond of \$0.00 that runs to the City and to 3rd parties that may be injured; and that secures the performance of the conditions specified in this privilege; and

WHEREAS, compensation of \$50.00 for this Privilege shall be paid into the general fund; and

WHEREAS, the holder of this Privilege is not entitled to damages for removal of an obstruction or excavation, and if the holder does not remove the obstruction or excavation upon due notice, it shall be removed at the holder's expense; and

WHEREAS, third parties whose rights are interfered with by the granting of this Privilege have a right of action against the holder of this Privilege only;

NOW THEREFORE, be it resolved by the Council of the City Of West Allis, in the State of Wisconsin, that the City of West Allis grants to Walter Holtz a privilege to place an obstruction beyond a lot line within a highway as described above and located adjacent to 7140-7144 W. Greenfield Ave., in the City of West Allis, WI

SECTION 1: **ADOPTION** “R-2022-0800” of the City Of West Allis Municipal Resolutions is hereby *added* as follows:

ADOPTION

R-2022-0800(Added)

PASSED AND ADOPTED BY THE CITY OF WEST ALLIS COUNCIL

_____.

	AYE	NAY	ABSENT	ABSTAIN
Ald. Vince Vitale	_____	_____	_____	_____
Ald. Tracy Stefanski	_____	_____	_____	_____
Ald. Marty Weigel	_____	_____	_____	_____
Ald. Suzzette Grisham	_____	_____	_____	_____
Ald. Danna Kuehn	_____	_____	_____	_____
Ald. Thomas Lajsic	_____	_____	_____	_____
Ald. Dan Roadt	_____	_____	_____	_____
Ald. Rosalie Reinke	_____	_____	_____	_____
Ald. Kevin Haass	_____	_____	_____	_____

Attest

Presiding Officer

Rebecca Grill, City Clerk, City Of
West Allis

Dan Devine, Mayor, City Of West
Allis

7140 W. Greenfield Ave.

Grant of Privilege



EXTERIOR RENDERING - REFER TO CONSTRUCTION DRAWINGS FOR DETAILS

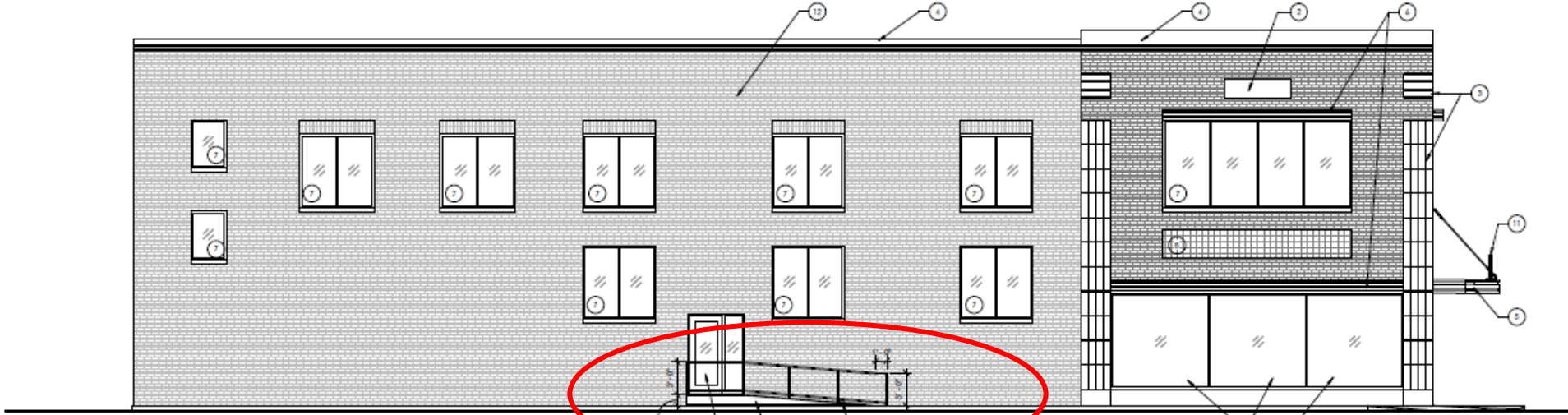

1 WEST ELEVATION
3/16" = 1'-0"

REVISIONS

NO.	DATE	DESCRIPTION

PROJECT INFO

Original Issue Date	
GC PROJECT	
Project No.	
Scale	
Drawn	

SHEET TITLE
EXTERIOR ELEVATIONS

A5.0

FOR CONSTRUCTION

FLOOR PLAN GENERAL NOTES:

- A. INDICATES WALL TYPE. SEE WALL SCHEDULE FOR WALL ASSEMBLY INFORMATION. NOTE: SEE SECTIONS AND ELEVATIONS FOR CHANGES IN MATERIALS/WALL TYPES/ACCENT-ELEMENTS THAT MAY NOT BE INDICATED @ PLAN CUT.
- B. SEE A1.0 FOR TYPICAL DIMENSIONS OF DOOR OPENING FROM ADJACENT WALL.
- C. PROVIDE FIRE TREATED BLOCKING AT MILLWORK AND WALL HUNG ELEMENTS IN RATED WALLS.
- D. INDICATES NEW MILLWORK. SEE INTERIOR ELEVATIONS AND DETAILS.
- E. INDICATES NEW FIRE EXTINGUISHER LOCATION.
- F. PROVIDE ROOF PATCHING AT ALL REQUIRED MECHANICAL PENETRATIONS PER ROOF MANUFACTURER'S RECOMMENDATIONS TO MAINTAIN WARRANTY.
- G. MODIFY EXISTING NFPA 13 AUTOMATIC SPRINKLER SYSTEM AS REQUIRED PER NEW FLOOR PLAN.
- H. A THERMAL BREAK IN THE CONCRETE FLOOR SLAB IS REQUIRED AT ALL EXTERIOR DOOR LOCATIONS: SEE DOOR DETAILS FOR MORE INFORMATION.
- I. ALL WALLS TO EXTEND TO UNDERSIDE OF FLOOR ROOF DECK U.N.O.
- J. ALL PARTITION PENETRATIONS SHALL BE FIELD VERIFIED & BRACED & SEALED AS REQUIRED.
- K. CONTRACTOR SHALL COORDINATE MILLWORK INSTALLATION & PROVIDE BLOCKING AS REQUIRED FOR THE SUPPORT OF SUCH MILLWORK TYP.
- L. PROVIDE PROPER PREPARATION TO ALL SURFACES TO RECEIVE NEW FINISHES.
- M. GC RESPONSIBLE FOR VERIFYING NEW WALLS DO NOT INTERFERE WITH ANY EXISTING ABOVE CEILING MEP SERVICES AND MAINTENANCE ACCESS TO THEM. IF A CONFLICT ARISES, IMMEDIATELY CONTACT THE ARCHITECT AND BUILDING MANAGEMENT/ENGINEERING BEFORE FRAMING WALLS.
- N. WHERE FLOOR DRAINS ARE REQUIRED (SEE PLUMBING) PITCH CONCRETE SLAB TO DRAINS 1/8" PER FOOT, TYP. UNLESS NOTED OTHERWISE.
- O. PATCH AND REPAIR EXISTING WALLS TO REMAIN AS REQUIRED TO RECEIVE NEW FINISHES.



KEYED FLOOR PLAN NOTES	
TAG #	DESCRIPTION
1	PROVIDE BLOCKING IN WALL FOR NEW WALL-MOUNTED MIRRORS.
2	PROVIDE BLOCKING IN WALL FOR WALL-MOUNTED TV.
3	NEW 1/2" STOP DOUBLE SIDED ELEVATOR. GC TO COORDINATE WITH ELEVATOR PROVIDER FOR EXACT SHAFT REQUIREMENTS.
4	REPLACE WALL FROM DOOR REMOVAL. NEW WALL TYPE TO MATCH EXISTING.
5	ELECTRICIAN TO COORDINATE WITH ELEVATOR MANUFACTURER FOR POWER REQUIREMENTS IN MACHINE ROOM.
6	PROVIDE NEW DOOR HARDWARE (HW) ON EXISTING DOORS NOTED.
7	PROVIDE NEW DOOR HARDWARE (HW) ON EXISTING DOORS NOTED.
8	PROVIDE NEW DOOR HARDWARE (HW) ON EXISTING DOORS NOTED.
9	PROVIDE NEW PANIC BAR EXIT DEVICE (SEE HW) AND ALL OTHER EXISTING HARDWARE TO REMAIN.
10	PROVIDE NEW DOOR HARDWARE (HW) ON EXISTING DOORS NOTED.
11	RECONSTRUCT EXISTING STAIRS, GUARDS, AND HANDRAILS FOR NEW PLAN LAYOUT.
12	NEW WOOD STAIRS, GUARDS, AND HANDRAILS. EXACT FINISHES TO BE DETERMINED.
13	EXISTING STAIRS NOT IN SCOPE.
14	NEW CODE COMPLIANT WALL-MOUNTED HANDRAIL - 1" ROUND BRASS RAIL, MOUNTED 36" A.F.F.
15	NEW CAPMODIFIED EXISTING GUARD RAILS. RAISE EXISTING GUARD RAILS TO 42" A.F.F. ADD CODE COMPLIANT HANDRAIL AT EXISTING STAIRS. 1" ROUND BRASS RAIL, MOUNTED 36" A.F.F.
16	NEW 1/2" HIGH QUARTZ COUNTERTOP FOR BAR & RESTROOMS.
17	PROVIDE NEW STAIRS AND HANDRAILS TO DISPLAY AREA.
18	NEW WOOD SHEET WITH STAINLESS STEEL COAT ROD.
19	NEW 2" HIGH 2" AM TRANSPARENT TOP. SEE SINK 1 FOR DETAILS.
20	NEW QUARTZ VANITY TOP WITH UNDERMOUNT SINK AND FAUCET. SEE 4A.2 FOR DETAILS.
21	PROVIDE NEW FLOOR-MOUNTED TOILET AND/OR WALL-MOUNTED URINAL AND TOILET PARTITIONS. GC TO PROVIDE GRAB BARS IN ADA STALLS AS REQUIRED PER CODE. SEE A1.0 FOR DETAILS.
22	PROVIDE NEW 2" X 4" FLOOR SET MOP SINK.
23	EXISTING 3-BASIN SINK. OWNER TO PROVIDE GC TO INSTALL.
24	NEW ALUMINUM ENTRY DOOR MEET SCHEDULE. SEE A1.0 FOR DETAILS.
25	NEW CONCRETE LANDING AND RAMP. 1:13 MAX SLOPE. VERIFY EXACT GRADE CHANGE IN FIELD. PROVIDE NEW PAINTED STEEL HANDRAILS. SEE ELEVATION.
26	SEE MANOR.
27	FOR DOT NOTED COLUMNS WITH WOOD STUDS. QTY: 86' AND WOOD. EXACT DESIGN TBD.
28	PROVIDE NEW FLOOR-MOUNTED TOILET WITH WALL-MOUNTED SINK AND GRAB BARS. SEE A1.0 FOR DETAILS.
29	IF CMU WALL @ 8" O.C. SEE ENLARGED PLANS FOR FOUNDATION AND STRUCTURAL DETAILS.
30	MAINTAIN 4" MINIMUM FROM RAMP TO EDGE OF SIDEWALK.
31	EXISTING 8" CMU WALL.
32	ADD 1" LAYER OF TYPE X GYP. BOARD TO BOTH SIDES OF EXISTING WALL AS SHOWN. QTY: BOARD TO EXTEND TO UNDERSIDE OF DECK.
33	NEW 4 BASIN UNDER BAR SINK. INCLUDES HANDWASH SINK.
34	ADD TYPE X GYP TO EXISTING WALLS ENCLOSING CLOSET TO CREATE 1-HR RATED WALL ASSEMBLY. SEE RCP FOR CEILING RATING.
35	EXISTING FENCE/CUMPTER SCREENING.
36	NEW 4" CASSED OPENING.
37	WALL MOUNTED HANDWASH SINK.

ELECTRICAL DATA PLAN GENERAL NOTES:

- A. CONTRACTOR TO VERIFY ELECTRICAL NEEDS WITH FURNITURE PROVIDER AND OWNER AS REQUIRED FOR NEW FURNITURE LAYOUT. THIS INCLUDES PROVIDING POWER AS REQUIRED AT CENTER OF ROOMS.
- B. ALL ELECTRICAL DEVICES AND COVER PLATES TO WHITE.
- C. KEEP EXISTING OUTLETS WHERE POSSIBLE. EXISTING OUTLETS NOT LOCATED ON PLANS. REPLACE ALL EXISTING ELECTRICAL DEVICES AND COVER PLATES WITH NEW WHITE DEVICES AND COVER PLATES. THIS INCLUDES EXISTING THERMOSTATS/THERMOSTAT COVERS IN AREA OF WORK ONLY.
- D. PROVIDE NEW THERMOSTATS AS REQUIRED.
- E. ALL SWITCHING TO BE CODE COMPLIANT. PROVIDE 3-WAY SWITCHING AT CORNERS.
- F. CONTRACTOR TO VERIFY LAYOUT OF ELECTRICAL DEVICES WITH ARCHITECT PRIOR TO INSTALLATION. SEE PLAN FOR PROPOSED POWER DATA LOCATIONS.
- G. ALL LOW VOLTAGE BY TENANT.

POWER & DATA SYMBOLS	
	NEW DUPLEX OUTLET
	NEW QUADPLEX OUTLET
	NEW MUD RING, PULL STRING, & CONDUIT FOR LOW VOLTAGE
	POWER FOR EXHAUST FAN

THIS DRAWING INDICATES THE GENERAL LOCATION OF FIXTURES, ARCHITECTURAL DETAILS, AND FINISHES. DESIGN/BUILD ELECTRICIAN SHALL REVIEW LIGHTING SPECIFICATIONS AND PROVIDE ANY AND ALL REQUIRED ASSOCIATED ACCESSORIES, WIRING, JUNCTION BOXES, ETC., WHICH MAY NOT BE EXPLICITLY IDENTIFIED IN THE DRAWINGS.

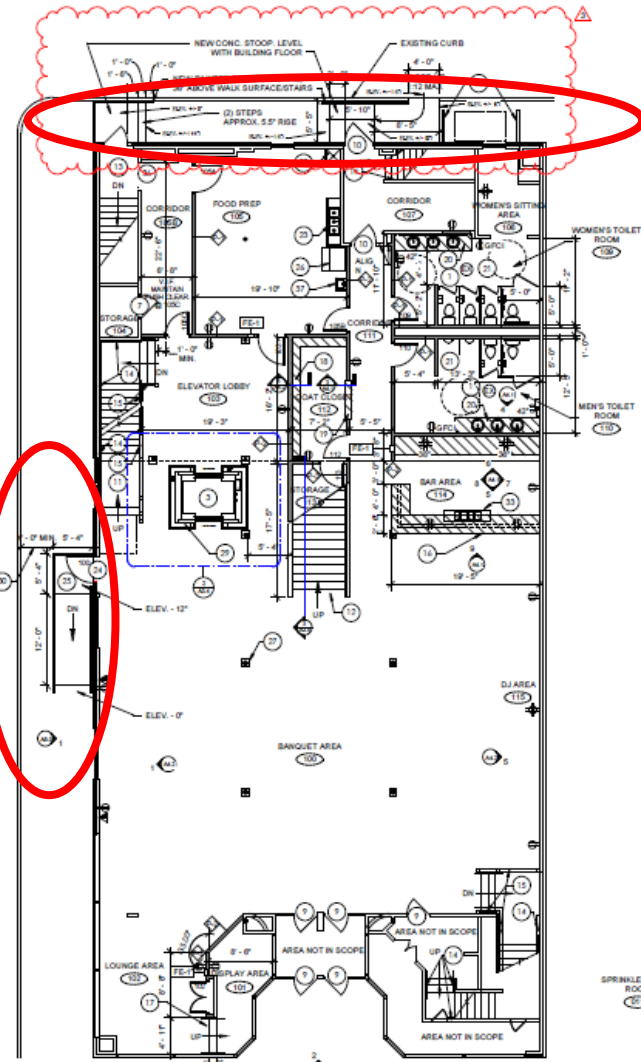

2 CONSTRUCTION PLAN - 1ST FLOOR
1/8" = 1'-0"

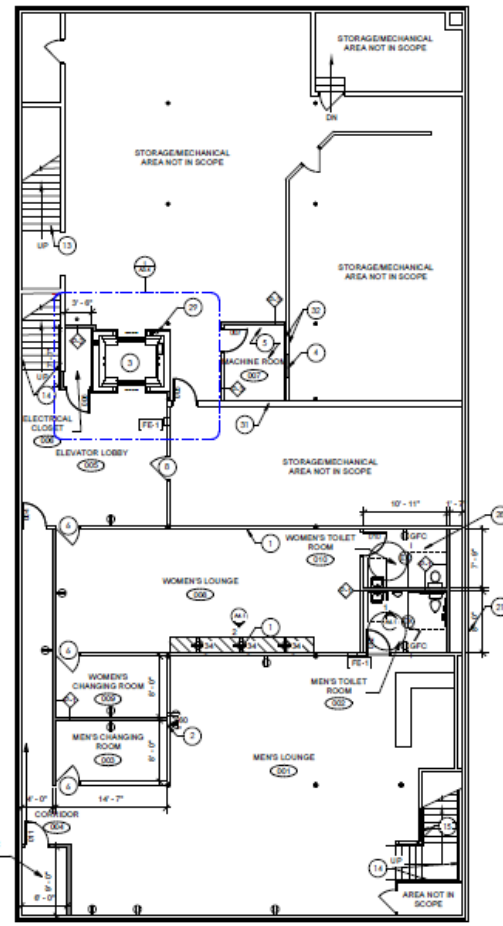

1 CONSTRUCTION PLAN - BASEMENT
1/8" = 1'-0"

in.studio
architecture

833 E. Michigan St., Suite 640 | Milwaukee, WI 53202
ph. 414.276.6904 | www.in.studio.arch.com

TENANT IMPROVEMENT FOR:
THE DECO
7140 W. GREENFIELD AVE.
WEST ALLIS, WI 53214

REVISIONS

NO.	REVISED	DATE	BY	APP.
1	ISSUED			

PROJECT INFO

Original Issue Date	
REVISED	
Project No.	
Scale	
Drawn	
ITL	

SHEET TITLE
CONSTRUCTION PLAN

A3.2

FOR CONSTRUCTION

Closeup of West Elevation

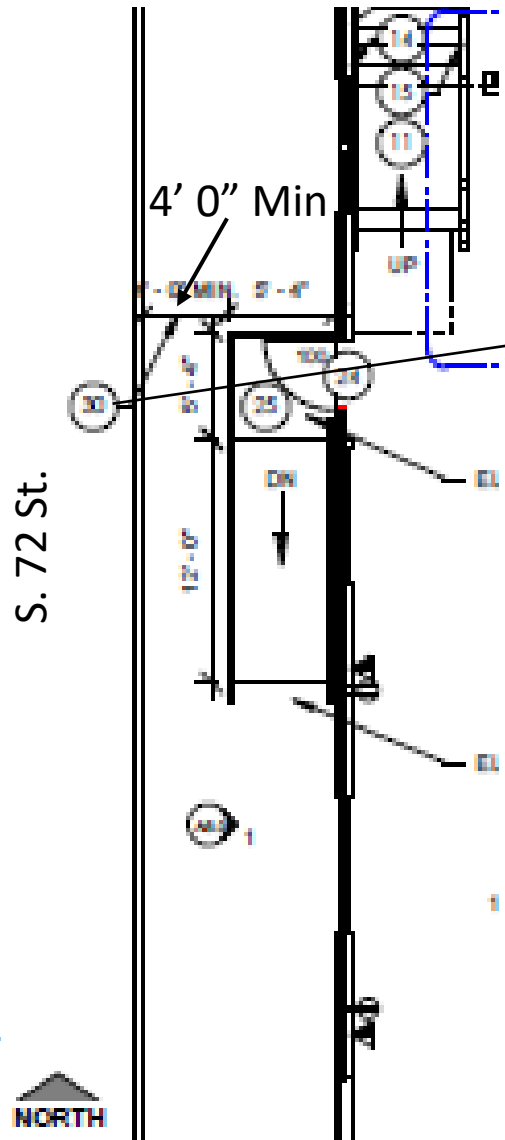

24	NEW ALUMINUM ENTRY DOOR WITH SIDELITE, SEE A4.0 FOR DETAILS.
25	NEW CONCRETE LANDING AND RAMP, 1:12 MAX SLOPE, VERIFY EXACT GRADE CHANGE IN FIELD. PROVIDE NEW PAINTED STEEL HANDRAILS, SEE ELEVATION

29	8" CMU W/ #5 @32" O.C. SEE ENLARGED PLANS FOR FOUNDATION AND STRUCTURAL DETAILS.
30	MAINTAIN 4' MINIMUM FROM RAMP TO EDGE OF SIDEWALK.

Closeup of North Elevation

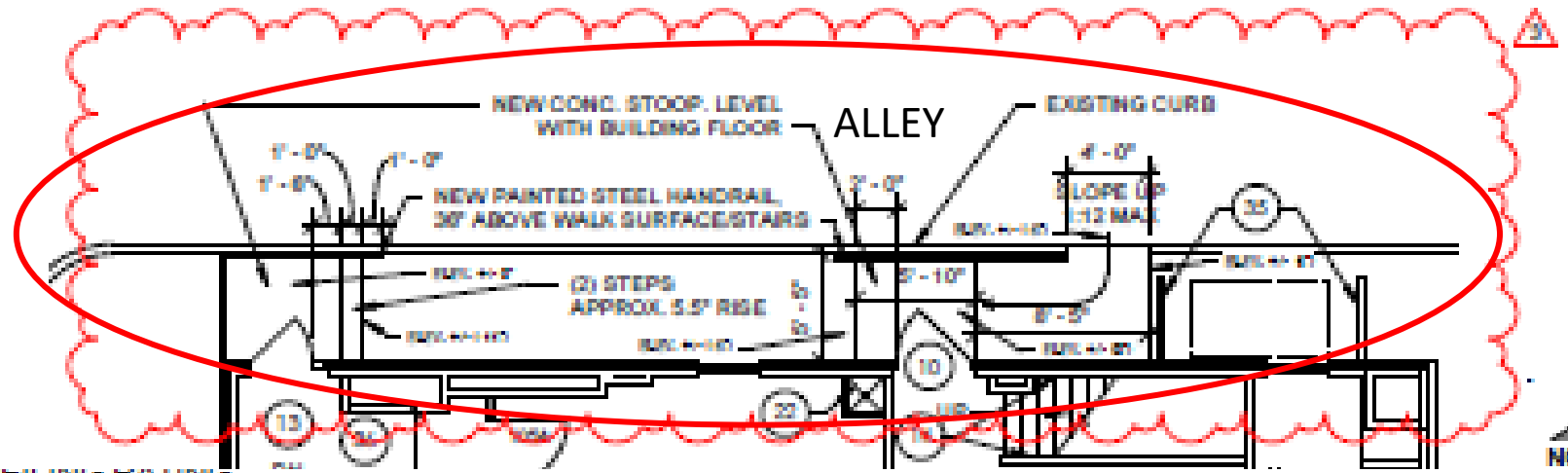

35	EXISTING FENCE/DUMPSTER SCREENING
----	-----------------------------------

BART-404

Operator's License (Bartender)

Status: Active

Date Created: Oct 28, 2022

Applicant

Seth House
almssth@gmail.com
2747 North 53rd Street
MILWAUKEE, WI 53210
4145543577

Operator's License (Bartender)

Check here if applying in person.

Regular or Temporary?

Regular

New or Renewal?

New

Applicant Information

Name Prefix

--

First Name

Seth

MI

H

Last Name

House

Name Suffix

--

Date of Birth

07/13/1989

Applicant's Driver License or State ID Number

H2007888925308

State Issued

WI

The City Clerk may issue a temporary operator's license only to persons employed by or donating their services to nonprofit corporations. A person is limited to only one such license in a year. The license is valid for any period from one to fourteen (14) days, and the period must be indicated on the license.

Other Names Used by Applicant

--

Phone Number

4145543577

Email Address

ALMSsth@gmail.com

Mailing Street Address (if different from applicant address)

2747 N 53rd St

Mailing Address City

Milwaukee

Mailing State

Wisconsin

Mailing Zip

53210

Anyone applying for an operator's license must complete the Responsible Beverage Server Training course or show proof that they have been a licensed operator in the last two years in another Wisconsin municipality.

Please Answer the Following

Have you completed an approved Responsible Beverage Server Training Course within the past two (2) years?

Yes

Date Responsible Beverage Server Course Completed

10/28/2022

Based on your responses to the previous two questions, you are ineligible for an Operator's License. Your application cannot be processed without the required responsible beverage server course training. Once you have completed the training, please resume your application.

Name of employer/business/organization you will be working for?

Randy's Neighbors Inn

I certify that I am over the age of eighteen (18) and that the completed statements are true and correct.

Yes

You are not eligible for an operator's license.

Provisional License

Do you wish to purchase a provisional license for an additional \$15.00?

No

Authorization

By signature below, the undersigned understands and agrees to the following: I DO HEREBY make application for an operator's license, to dispense alcoholic beverages on premises requiring a retail Class A, Class B, or Class C license, all subject to provisions of and limitations imposed by Wis. Stats. Ch. 125 and West Allis Municipal Code - Ch. 9. I DECLARE UNDER PENALTY OF LAW that all of the above information is true and correct to the best of my knowledge and belief. Incomplete, incorrect, or false information may lead to denial or revocation of this license. Any person who knowingly provides materially false information on an application may be required to forfeit up to \$1,000.

Signature

Seth H House
10/28/2022

I understand that I must submit a fee payment in order for my application to be processed. (You will receive an email with a link to pay, once you have submitted your application.)



Do you wish to purchase a license card for an additional \$10.00? This is not required to bartend.



Police Department Review

DL

Valid

Click box if there are not any DOT Violations



DOT Notes

12/18/2017 DEFECTIVE SPEEDOMETER; 07/12/2018 SPEEDING INTERMEDIATE 11-19 OVER; 12/18/2018 RESTRICTIONS ON PARKING AND STOPPING; 10/12/2020 IMPRUDENT SPEED; 10/28/2020 ACCIDENT INJURY; 11/16/2020 SIGNAL VIOLATION

Click box if there are not any Local Violations



Locals Notes

--

Clerk Administration Information

Review WORCS report for record. Remember to check the box ok to issue, yes/no

WORCS Attachment

 House, Seth.pdf

Uploaded by Jenny Slivka on Oct 28, 2022 at 4:18 pm

Click here if there are not any WORCS records.



WORCS Notes

--

Okay to Issue?

No

Needs Admin/Clerk Review?

Yes

Clerk Review - Issue or Schedule LH Hearing

Schedule LH Appearance

LH / CC Action

Don't do complete step until the time the notice should be sent.

License and Health Date

11/15/2022

License and Health Time

7:00 pm

Meeting Room

Room 128

License and Health Recommendation

--

Common Council Date

Common Council Tentative Decision

--
Common Council Final Decision (do not complete until after the council makes a decision as the license will be issued or denial letter sent right away after you enter the information)
--

ATTENTION APPLICANT!!!

ALL communications regarding the licenses/permits you apply for is done through OpenGov.

You will be notified by email when your request is approved/denied, when someone posts a comment, asks a question or uploads a document to your application.

Prior to submitting your application, please add the email address **noreply@viewpointcloud.com** to your address book to ensure you receive the City's communications regarding your request.

Thank you.

ATTENTION APPLICANT!!!

Attachments



20220928_152310.jpg

Uploaded by Seth House on Oct 28, 2022 at 3:10 pm

 TIPS Wisconsin On-Premise Alcohol Server Training_27084579.pdf











Uploaded by Seth House on Oct 28, 2022 at 3:10 pm

History

Date	Activity
Oct 28, 2022 at 3:02 pm	Seth House started a draft of Record BART-404
Oct 28, 2022 at 3:11 pm	Seth House submitted Record BART-404
Oct 28, 2022 at 3:11 pm	changed the deadline to Oct 31, 2022 on payment step Fee Payment on Record BART-404
Oct 28, 2022 at 3:12 pm	completed payment step Fee Payment on Record BART-404
Oct 28, 2022 at 3:12 pm	changed the deadline to Oct 31, 2022 on approval step CSC (In-Person) or Clerk's Office (Online) Application Review on Record BART-404
Oct 28, 2022 at 3:12 pm	approval step CSC (In-Person) or Clerk's Office (Online) Application Review was assigned to Jenny Slivka on Record BART-404
Oct 28, 2022 at 3:12 pm	changed the deadline to Oct 31, 2022 on approval step CSC (In-Person) or Clerk's Office (Online) Application Review on Record BART-404
Oct 28, 2022 at 3:46 pm	Jenny Slivka approved approval step CSC (In-Person) or Clerk's Office (Online) Application Review on Record BART-404
Oct 28, 2022 at 3:46 pm	approval step Dispatch was assigned to Police Amber Alert Group on Record BART-404
Oct 28, 2022 at 3:46 pm	changed the deadline to Oct 31, 2022 on approval step Dispatch on Record BART-404
Oct 28, 2022 at 3:46 pm	approval step Police Background Review was assigned to Lisa Bergmann on Record BART-404

Date	Activity
Oct 28, 2022 at 3:46 pm	changed the deadline to Oct 31, 2022 on approval step Police Background Review on Record BART-404
Oct 28, 2022 at 4:01 pm	Police Amber Alert Group approved approval step Dispatch on Record BART-404
Oct 28, 2022 at 4:11 pm	Lisa Bergmann changed DL from "" to "Valid" on Record BART-404
Oct 28, 2022 at 4:13 pm	Lisa Bergmann changed DOT Notes from "" to "12/18/2017 DEFECTIVE SPEEDOMETER; 07/12/2018 SPEEDING INTERMEDIATE 11-19 OVER; 12/18/2018 RESTRIC" on Record BART-404
Oct 28, 2022 at 4:13 pm	Lisa Bergmann changed Click box if there are not any Local Violations from "" to "true" on Record BART-404
Oct 28, 2022 at 4:13 pm	Lisa Bergmann approved approval step Police Background Review on Record BART-404
Oct 28, 2022 at 4:13 pm	approval step Clerk Review was assigned to Jenny Slivka on Record BART-404
Oct 28, 2022 at 4:13 pm	changed the deadline to Oct 31, 2022 on approval step Clerk Review on Record BART-404
Oct 28, 2022 at 4:18 pm	Jenny Slivka changed WORCS Attachment from "" to "11694" on Record BART-404
Oct 28, 2022 at 4:18 pm	Jenny Slivka changed Okay to Issue? from "" to "No" on Record BART-404
Oct 28, 2022 at 4:18 pm	Jenny Slivka changed Needs Admin/Clerk Review? from "" to "Yes" on Record BART-404
Oct 28, 2022 at 4:18 pm	Jenny Slivka approved approval step Clerk Review on Record BART-404
Oct 28, 2022 at 4:18 pm	changed the deadline to Oct 31, 2022 on approval step Admin/Clerk Review Records/Violations on Record BART-404
Oct 28, 2022 at 4:18 pm	approval step Admin/Clerk Review Records/Violations was assigned to Rebecca Grill on Record BART-404
Oct 28, 2022 at 4:18 pm	changed the deadline to Oct 31, 2022 on approval step Admin/Clerk Review Records/Violations on Record BART-404
Oct 28, 2022 at 4:24 pm	Rebecca Grill changed Clerk Review - Issue or Schedule LH Hearing from "" to "Schedule LH Appearance" on Record BART-404
Oct 28, 2022 at 4:24 pm	Rebecca Grill changed License and Health Date from "" to "11/15/2022" on Record BART-404
Oct 28, 2022 at 4:24 pm	Rebecca Grill changed License and Health Time from "" to "7:00 pm" on Record BART-404
Oct 28, 2022 at 4:24 pm	Rebecca Grill changed Meeting Room from "" to "Room 128" on Record BART-404
Oct 28, 2022 at 4:24 pm	Rebecca Grill approved approval step Admin/Clerk Review Records/Violations on Record BART-404
Oct 28, 2022 at 4:24 pm	approval step Create Legistar File & Enter # in Note Area was assigned to Agenda (City Clerk Legistar File Request) on Record BART-404
Oct 31, 2022 at 4:00 pm	Rebecca Grill assigned approval step Hearing Information to Rebecca Grill on Record BART-404
Oct 31, 2022 at 4:00 pm	Rebecca Grill changed the deadline to Nov 09, 2022 on approval step Hearing Information on Record BART-404

Timeline

Label	Status	Activated	Completed
 Fee Payment	Paid	Oct 28, 2022 at 3:11 pm	Oct 28, 2022 at 3:12 pm
 CSC (In-Person) or Clerk's Office (Online) Application Review	Complete	Oct 28, 2022 at 3:12 pm	Oct 28, 2022 at 3:46 pm
 Dispatch	Complete	Oct 28, 2022 at 3:46 pm	Oct 28, 2022 at 4:01 pm
 Police Background Review	Complete	Oct 28, 2022 at 3:46 pm	Oct 28, 2022 at 4:13 pm
 Clerk Review	Complete	Oct 28, 2022 at 4:13 pm	Oct 28, 2022 at 4:18 pm
 Admin/Clerk Review Records/Violations	Complete	Oct 28, 2022 at 4:18 pm	Oct 28, 2022 at 4:24 pm
 Create Legistar File & Enter # in Note Area	Active	Oct 28, 2022 at 4:24 pm	-
 Hearing Information	Active	Oct 31, 2022 at 4:01 pm	-
 Hearing Notice	Inactive	-	-
 City Attorney Summarize Record	Inactive	-	-
 Enter L&H and Common Council Decision	Inactive	-	-



City Clerk
clerk@westalliswi.gov

November 7, 2022

Seth House
Milwaukee
2747 North 53rd Street
MILWAUKEE, WI 53210

RE: Operator's License Application Review

Dear Seth;

Your application for an Operator's/Bartender License is scheduled for a televised hearing before the License and Health Committee on: **November 15, 2022 at 6:30 pm in Room 128 at City of West Allis, City Hall, 7525 W. Greenfield Avenue, West Allis.**

The reason for the hearing is based upon information from your background check relating to conviction(s) for a felony, misdemeanor, or other offense; and/or habitual law offenses. The circumstances of the offenses substantially relate to the operation of a licensed premise because the conduct demonstrates irresponsible or illegal use of alcohol and/or drugs and/or noncompliance with licensing rules and regulations.

You are allowed to show competent evidence of rehabilitation and fitness to engage in the operation of a premises licensed to serve alcohol (Wis. Stat. §111.335(4)(c)1.b.)* See page 2 for additional information.

If you fail to appear you waive your opportunity to be heard to present your evidence of rehabilitation and your license application could be denied. If your license is denied, you will have to wait six months from the date of denial to reapply.

Please park in the parking lot on the south side of the building. Room 128 is the first room on your right when you enter the building. The Art Gallery is located in the lower level through glass doors.

If you have questions, please email clerk@westalliswi.gov.

Pursuant to Wisconsin Statute Section 111.335(4)(d)1, competent evidence of rehabilitation may include:

- A certified copy of a federal department of defense form showing honorable discharge or similar cessation of military service
- A copy of local, state, or federal release documents showing completion of probation, extended supervision, or parole
- Evidence that at least one year has lapsed since release from local, state, or federal custody without a new offense and compliance with terms of supervision



An applicant may also provide information regarding:

- Evidence of the nature and seriousness of the offense
- The circumstances relative to the offense, including mitigating or social conditions
- The age of the applicant at the time of the offense
- The length of time that has lapsed since the offense
- Letters of reference
- Any other relevant evidence of rehabilitation and present fitness.

Operator's License (Bartender)**BART-413**

Submitted On: Nov 3, 2022

Applicant

 Corey Curtis
 2622261575
 ccurtis4986@gmail.com

Operator's License (Bartender)**Regular or Temporary?**

Regular

New or Renewal?

New

Applicant Information**Name Prefix**

Mr

First Name

Corey

MI

J

Last Name

Curtis

Name Suffix

--

Date of Birth

06/08/1994

Applicant's Driver License or State ID Number

C632-1109-4208-00

State Issued

WI

Other Names Used by Applicant

--

Phone Number

2622261575

Email Address

Ccurtis4986@gmail.com

Mailing Street Address (if different from applicant address)

--

Mailing Address City

--

Mailing State

--

Mailing Zip

--

Anyone applying for an operator's license must complete the Responsible Beverage Server Training course or show proof that they have been a licensed operator in the last two years in another Wisconsin municipality.

Please Answer the Following

Have you completed an approved Responsible Beverage Server Training Course within the past two (2) years?

Yes

Date Responsible Beverage Server Course Completed

07/06/2022

Name of employer/business/organization you will be working for?

Natty oaks

I certify that I am over the age of eighteen (18) and that the completed statements are true and correct.

Yes

Provisional License

Do you wish to purchase a provisional license for an additional \$15.00?

No

Authorization

By signature below, the undersigned understands and agrees to the following: I DO HEREBY make application for an operator’s license, to dispense alcoholic beverages on premises requiring a retail Class A, Class B, or Class C license, all subject to provisions of and limitations imposed by Wis. Stats. Ch. 125 and West Allis Municipal Code - Ch. 9. I DECLARE UNDER PENALTY OF LAW that all of the above information is true and correct to the best of my knowledge and belief. Incomplete, incorrect, or false information may lead to denial or revocation of this license. Any person who knowingly provides materially false information on an application may be required to forfeit up to \$1,000.

Signature

true

I understand that I must submit a fee payment in order for my application to be processed. (You will receive an email with a link to pay, once you have submitted your application.)

true

Do you wish to purchase a license card for an additional \$10.00? This is not required to bartend.

false

ATTENTION APPLICANT!!!

ALL communications regarding the licenses/permits you apply for is done through OpenGov.

You will be notified by email when your request is approved/denied, when someone posts a comment, asks a question or uploads a document to your application.

Prior to submitting your application, please add the email address **noreply@viewpointcloud.com** to your address book to ensure you receive the City’s communications regarding your request.

Thank you.

ATTENTION APPLICANT!!!



City Clerk
clerk@westalliswi.gov

November 8, 2022

Corey Curtis

2086 s 105th st
West allis, WI 53227

RE: Operator's License Application Review

Dear Corey;

Your application for an Operator's/Bartender License is scheduled for a televised hearing before the License and Health Committee on: **November 15, 2022 at 6:30 pm in Room 128 at City of West Allis, City Hall, 7525 W. Greenfield Avenue, West Allis.**

The reason for the hearing is based upon information from your background check relating to conviction(s) for a felony, misdemeanor, or other offense; and/or habitual law offenses. The circumstances of the offenses substantially relate to the operation of a licensed premise because the conduct demonstrates irresponsible or illegal use of alcohol and/or drugs and/or noncompliance with licensing rules and regulations.

You are allowed to show competent evidence of rehabilitation and fitness to engage in the operation of a premises licensed to serve alcohol (Wis. Stat. §111.335(4)(c)1.b.)* See page 2 for additional information.

If you fail to appear you waive your opportunity to be heard to present your evidence of rehabilitation and your license application could be denied. If your license is denied, you will have to wait six months from the date of denial to reapply.

Please park in the parking lot on the south side of the building. Room 128 is the first room on your right when you enter the building. The Art Gallery is located in the lower level through glass doors.

If you have questions, please email clerk@westalliswi.gov.

Pursuant to Wisconsin Statute Section 111.335(4)(d)1, competent evidence of rehabilitation may include:

- A certified copy of a federal department of defense form showing honorable discharge or similar cessation of military service
- A copy of local, state, or federal release documents showing completion of probation, extended supervision, or parole
- Evidence that at least one year has lapsed since release from local, state, or federal custody without a new offense and compliance with terms of supervision

An applicant may also provide information regarding:

- Evidence of the nature and seriousness of the offense
- The circumstances relative to the offense, including mitigating or social conditions
- The age of the applicant at the time of the offense
- The length of time that has lapsed since the offense
- Letters of reference
- Any other relevant evidence of rehabilitation and present fitness.

**WEST ALLIS COMMON COUNCIL
LICENSE AND HEALTH COMMITTEE
CITY OF WEST ALLIS**

**In the Matter of the
Complaint Against**

SUMMONS

**CRG Investments LLC
D/B/A Limanski's Pub**

**Premises Location:
8900 W. Greenfield Ave.
West Allis, WI 53214**

Agent: Kathy Goedde

**STATE OF WISCONSIN)
) ss.
COUNTY OF MILWAUKEE)**

**THE WEST ALLIS COMMON COUNCIL TO CRG Investments LLC by licensing
agent Kathy Goedde:**

You are hereby notified that a sworn complaint, a copy of which is attached, has been duly made and filed, requesting a hearing on suspension or revocation of the 2022-2023 "Class B" intoxicating liquor license, a Class "B" fermented malt beverage license, and a Public Entertainment Permit, all issued under license number ALC-22-148, for the premises located at 8900 W. Greenfield Avenue in the City of West Allis, State of Wisconsin, for the license period running July 1, 2022, and expiring on June 30, 2023. This sworn complaint requesting a hearing for suspension or revocation of the above referenced licenses or permits is brought pursuant to the provision of Wis. Stat. § 125.12(2) and West Allis Code §§ 9.51, 9.60(5), and 9.76(5).

NOW THEREFORE, you, CRG Investments LLC by licensing agent Kathy Goedde, are hereby summoned to appear before the License and Health Committee of the West Allis Common Council on November 15, 2022 at 6:30 p.m., in Room 128 of the West Allis City Hall located at 7525 W. Greenfield Avenue in the City of West Allis, or as soon thereafter as this matter can be heard, to admit or deny the allegations in the complaint. You may be represented by counsel on this date.

In the case of your failure to appear as required by this summons, the allegations in the complaint against you shall be taken as true and, if the License and Health Committee of the West Allis Common Council finds the allegations sufficient, a recommendation that your license(s) be suspended or revoked will be made to the full Common Council. The Common Council may then vote to suspend or revoke your license(s).

You are further notified that if you appear as required by this summons and contest the allegations in the complaint, a hearing will be scheduled at a later date before the License and Health Committee, at which time you may be represented by counsel, cross examine the witnesses who testify adversely against you, and present witnesses in your own behalf. A written transcript of said hearing shall be made and you may obtain a copy of the transcript of this proceeding at your expense.

Dated at West Allis, Wisconsin, this 7th day of November, 2022.

WEST ALLIS COMMON COUNCIL

By: Rebecca N. Grill
Rebecca Grill
City Administrator and City Clerk

**WEST ALLIS COMMON COUNCIL
LICENSE AND HEALTH COMMITTEE
CITY OF WEST ALLIS**

**In the Matter of the
Complaint Against**

COMPLAINT

**CRG Investments LLC
D/B/A Limanski's Pub**

**Premises Location:
8900 W. Greenfield Ave.
West Allis, WI 53214**

Agent: Kathy Goedde

**STATE OF WISCONSIN)
) ss.
COUNTY OF MILWAUKEE)**

Detective Brandon Hurley of the West Allis Police Department, being duly sworn on oath, deposes and states as a complaint under Wis. Stat. § 125.12(2)(ag) against CRG Investments LLC doing business as "Limanski's Pub" as follows:

1. That the complainant is a resident of the City of West Allis.
2. That this complaint is based upon information contained within official records maintained by the City of West Allis and the City of West Allis Police Department that the complainant has used in the past and found to be reliable.
3. That CRG Investments LLC does business as "Limanski's Pub" and currently holds a "Class B" intoxicating liquor license and a Class "B" fermented malt beverage license (together identified on the license as a "Class B Tavern License"), and a Public Entertainment Permit, all issued under license number ALC-22-148, for the

premises located at 8900 W. Greenfield Avenue in the City of West Allis, State of Wisconsin, for the license period running July 1, 2022 to June 30, 2023.

4. That Kathy Goedde is the agent appointed pursuant to Wis. Stat. § 125.04(6)(a) for license number ALC-22-148.
5. That the premises has held a "Class B" intoxicating liquor license and a Class "B" fermented malt beverage license for several years, with the prior license being issued under license number 2021-072 for the license period running July 1, 2021, through June 30, 2022.
6. That on or about June 22, 2022, police were dispatched to Limanski's Pub located at 8900 W. Greenfield Avenue for a large fight in progress. Police arrived on the scene and observed a large group of people outside the bar. Officers were able to determine that there was a verbal disagreement between two groups that originated inside the bar before that altercation moved outside the bar and into the community. Police were able to determine that one group associated with the fight remained outside the bar while another party involved in the fight had been moved by bar staff to the basement of the bar.

Officer Lonnie Christianson made contact with Dale W. who was one of the parties identified as being involved in the fight and was still outside the bar. Officer Christianson identified that Dale W. was "very intoxicated," was profane, loud, and disorderly while outside the bar and in her contact with him.

Officers were notified that the other party involved in the fight may have pointed a gun at Dale W. Based on the nature of the call for service, police ordered the subject in the basement to exit the building and made contact with a subject, Michael R.

Body camera footage shows Limanski's Pub staff exiting the basement just before Michael R. comes out. Police conducted a consent search of the basement of the bar and found a firearm hidden in a freezer door by the stairs and a black bag with a label of "cookies" that contained approximately 195 grams of marijuana, 5.13 grams of methamphetamine, and 7.55 grams of cocaine. Police investigation revealed that the gun and drugs were taken to the basement by Michael R. in this incident.

Police recovered surveillance video showing a portion of the basement of the bar. That video depicts at least one male employee, believed to be Michael N., of Limanski's Pub present in the basement with Michael R. as he makes attempts to conceal gun and drugs. This male employee can be seen entering and exiting the video and is also the same male employee that police see exit the basement ahead of Michael R.

7. That on August 14, 2022, at approximately 12:45 AM, police were dispatched to Limanski's Pub for a physical fight outside the bar. Police identified that a bar patron identified as Nicole K., was outside smoking a cigarette with her fiancé when two unknown parties pushed her and her fiancé. Police Officer Aric Behnke had contact with the bartender on duty, Michael N. who reported that he was not aware of any problems. Michael N. is the same employee observed in the basement during the June 22, 2022 incident.
8. That on September 9, 2022, police were dispatched to Limanski's Pub for a battery complaint. Police made contact with Brian D. who reported the assault at the bar. Officer laquinta reported that he made contact with Brian D., who was apparently highly intoxicated. Officer laquinta made contact with bartender Michael N. who

stated that there was only a verbal altercation with the patrons. This Michael N. is the same employee seen in the basement on June 22, 2022, and referenced in the August 14th, 2022 altercation.

9. That on October 9, 2022, at approximately 3:30 AM, police were dispatched to Limanski's Pub for a report of an assault. Police determined that a male party had been assaulted outside the bar and a gold necklace was removed from his neck. There were no known suspects. When police arrived on scene just after 3:30 AM, they determined that there were still patrons inside Limanski's Pub. One citation was issued to Michael N. (same bartender identified in all prior incidents) for allowing patrons to remain on the premises after closing.
10. That later that same day on October 9, 2022, at approximately 8:22 PM, police responded to Limanski's Pub for a large fight inside the business. Officer Stelter obtained information that the fight seemed to originate within the bar before spilling out into the community. One community member with initials A.S. identified that she was watching tv at home when the fight exited the bar into the streets. She said some of the bar patrons entered her yard and continued fighting. One patron removed one of the rocks in her yard and attempted to throw it or use it as a weapon.

Officer Stelter had contact with bar owner Kathy Goedde regarding the incident. Police requested to view the bar's surveillance video, but Ms. Goedde stated it would take an hour to download the interior video. As of October 10, police did not get a return phone call that the footage was available.

11. That on October 23, 2022, police were dispatched to Limanski's Pub for a report of multiple assaults. Police determined that a subject by the name of Cassandra D. had assaulted two bar employees. Cassandra D. was identified as being highly intoxicated by bar staff, but she had fled prior to police arriving. Cassandra D. was issued multiple citations and a warrant was issued for her with probation and parole.

12. That pursuant to Wis. Stat. §125.12(2) any license issued under Wis. Stat. Ch. 125 is subject to suspension or revocation for any of the following:

- A. Violating Wis. Stat. § 125.07(2)(a)(2), per Wis. Stat. § 125.12(2)(ag)1. for serving persons who are intoxicated;
- B. Keeping or maintaining a disorderly or riotous, indecent or improper house in violation of Wis. Stat. § 125.12(2)(ag)2.; and
- C. Knowingly allowing another person or employee on the premises who possesses with the intent to distribute or deliver a controlled substance or controlled substance analog in violation of Wis. Stat. § 125.12(2)(ag)6.

13. That pursuant to West Allis Municipal Code §§ 9.51b. and 9.51d. the Public Entertainment Permit is subject to suspension or revocation when the operator has failed to maintain order on the premises and has caused a public nuisance at the property, demonstrated by the bar staff allowing individuals to hide drugs and gun, serving patrons past the point of intoxication, and maintaining a bar that is continually the catalyst for fights and violent behavior spilling out into the community.

WHEREFORE, Detective Brandon Hurley requests that the licensees named herein, CRG Investments LLC, be summoned to appear before the License and Health Committee of the West Allis Common Council to answer this complaint and, if the

material allegations of the complaint are denied, that a hearing be held to determine whether the licenses and permits issued to CRG Investments LLC, should be revoked or suspended.

Dated this 1st day of November, 2022.

By: Det. B. Hurley, #66

Print Name: Det. B. Hurley, #66
City of West Allis Police Department

Subscribed and sworn to before me
this 1 day of November, 2022.

Nicholas S. Cerwin
(Nicholas S. Cerwin)
Notary Public, State of Wisconsin
My Commission expires: Permanent

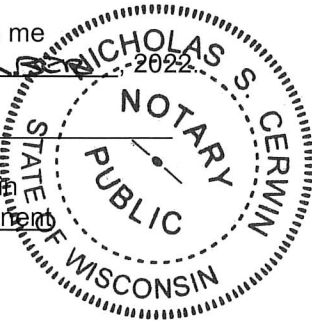

Affidavit of Process Server

Court/Appearance Date: 11/15/22
City of West Allis

Case Number _____
EKC Investments, LLC
Vs dba Kane's Bar & Grill

I the undersigned am an adult resident of the state of Wisconsin and not a party to the action. I hereby swear that on November 9 2022 at 12:55 p.m. I duly served/or attempted to serve, (see nonservice section)

NAME CRG Investments LLC dba Limanski's Bar

DEFENDANT PETITIONER OTHER ATTEMPTED DATES _____
 GARNISHEE DEFENDANT RESPONDENT
 PLAINTIFF WITNESS

By serving Hannah Milbauer Person in Charge _____ at _____
Home _____ Name _____ Title/Relationship _____ Wisconsin
Business 8900 W. Greenfield Ave. City of West Allis _____ Wisconsin

Manner of Service:

- Personal Service
- Corporate Service: by leaving, during office hours, copies at the office of the person/entity being served, leaving same with the person apparently in charge thereof.
- After diligent search and inquiry, having made _____ attempts by leaving true & correct copies of the above documents with a competent occupant of the residence over the age of 14 and informed that person of the contents thereof. (See other Attempt Dates)
- Posting copies in a conspicuous manner to the address of the person/entity being served. (Use only for evictions)
- Copies of the documents were mailed by prepaid, first-class mail on: _____ DATE _____ FROM _____

Nonservice: after due search, careful inquiry and diligent attempts at the address(s) listed above, I have been unable to effect process upon the person/entity being served because of the following reason(s):

- Unknown at address Moved no forwarding Refuses to cooperate in acceptance
- Address does not exist Evading Service cancelled by litigant
- Not home three attempts Unable to serve in a timely fashion Search was conducted, whereabouts unknown

The following attempts were made to personally serve Kathy Goedde (Registered Agent for CRG Investments LLC): 11/7/22 4:20pm (not in), 11/8/22 7:38pm (not in), 11/9/22 12:55pm (not in). On 11/7/22 server left contact information with staff. No response from Kathy Goedde.

Type of Documents:

- ELECTRONIC FILING NOTICE ORDER TO SHOW CAUSE & AFFIDAVIT
- SUMMONS AND COMPLAINT BLANK FINANCIAL DISCLOSURE STATEMENT
- NOTICE OF MOTION AND MOTION/AFFIDAVIT ADMINISTRATIVE DISMISSAL DATE
- NOTICE OF HEARING SUMMONS AND PETITION-DIVORCE
- COVER LETTER CONFIDENTIAL PETITION ADDENDUM
- SUBPOENA DUCES TECUM

At the time of service, I did place upon it the date, time, and my name, leaving a true and correct copy thereof, and that the server knew the person so served to be the defendant (or other) mentioned and named therein.

NUMBER OF ATTEMPTS 3 NUMBER OF ADDRESSES ATTEMPTED (if more than one) _____
SERVICE FEE \$ 35.00 WITNESS FEE \$ _____
FILING FEE \$ _____ SEARCH FEE \$ _____
TOTAL FEE \$ 35.00 MILEAGE \$ _____

Server's Name Carlton W. Manske Server's Signature Carlton Manske
(Print) _____

Subscribed and sworn to before me, _____
This _____ day of _____, 2022

Notary Public Waukesha Co., State of Wisconsin
My Commission expires 02/24/2026



Affidavit of Process Server

Court/Appearance Date: 11/15/22
City of West Allis

Case Number _____
EKC Investments, LLC
dba Kane's Bar & Grill

Vs

I the undersigned am an adult resident of the state of Wisconsin and not a party to the action. I hereby swear that on November 9 2022 at 12:40 p.m. I duly served/or attempted to serve, (see nonservice section)

NAME EKC Investments LLC dba Kane's Bar and Grill

DEFENDANT PETITIONER OTHER ATTEMPTED DATES _____
 GARNISHEE DEFENDANT RESPONDENT
 PLAINTIFF WITNESS

By serving Justin Duwe Kitchen Manager at _____
Name Title/Relationship
Home _____ Wisconsin
Business 6922 W. Orchard St. City of West Allis Wisconsin

Manner of Service:

- Personal Service
- Corporate Service: by leaving, during office hours, copies at the office of the person/entity being served, leaving same with the person apparently in charge thereof.
- After diligent search and inquiry, having made _____ attempts by leaving true & correct copies of the above documents with a competent occupant of the residence over the age of 14 and informed that person of the contents thereof. (See other Attempt Dates)
- Posting copies in a conspicuous manner to the address of the person/entity being served. (Use only for evictions)
- Copies of the documents were mailed by prepaid, first-class mail on: _____ DATE _____ FROM _____

Nonservice: after due search, careful inquiry and diligent attempts at the address(s) listed above, I have been unable to effect process upon the person/entity being served because of the following reason(s):

- Unknown at address Moved no forwarding Refuses to cooperate in acceptance
- Address does not exist Evading Service cancelled by litigant
- Not home three attempts Unable to serve in a timely fashion Search was conducted, whereabouts unknown

The following attempts were made to personally serve Ed Jones (Registered Agent of EKC Investments LLC): 11/7/22 4:08pm (business closed), 11/8/22 7:48pm (business closed), 11/9/22 12:40pm (not in).

Type of Documents:

- ELECTRONIC FILING NOTICE
- SUMMONS AND COMPLAINT
- NOTICE OF MOTION AND MOTION/AFFIDAVIT
- NOTICE OF HEARING
- COVER LETTER
- ORDER TO SHOW CAUSE & AFFIDAVIT
- BLANK FINANCIAL DISCLOSURE STATEMENT
- ADMINISTRATIVE DISMISSAL DATE
- SUMMONS AND PETITION-DIVORCE
- CONFIDENTIAL PETITION ADDENDUM
- SUBPOENA DUCES TECUM

At the time of service, I did place upon it the date, time, and my name, leaving a true and correct copy thereof, and that the server knew the person so served to be the defendant (or other) mentioned and named therein.

NUMBER OF ATTEMPTS 3 NUMBER OF ADDRESSES ATTEMPTED (if more than one) _____
SERVICE FEE \$ 35.00 WITNESS FEE \$ _____
FILING FEE \$ _____ SEARCH FEE \$ _____
TOTAL FEE \$ 35.00 MILEAGE \$ _____

Server's Name Carlton W. Manske (Print) Server's Signature Carlton Manske

Subscribed and sworn to before me
This _____ day of _____, 2022
Notary Public Waukesha Co., State of Wisconsin
My Commission expires 02/24/2026



**WEST ALLIS COMMON COUNCIL
LICENSE AND HEALTH COMMITTEE
CITY OF WEST ALLIS**

**In the Matter of the
Complaint Against**

SUMMONS

**EKC Investments LLC
D/B/A Kane’s Bar & Grill**

**Premises Location:
6922 W. Orchard St.
West Allis, WI 53214**

Agent: Ed Jones

**STATE OF WISCONSIN)
) ss.
COUNTY OF MILWAUKEE)**

**THE WEST ALLIS COMMON COUNCIL TO EKC Investments LLC by licensing
agent Ed Jones:**

You are hereby notified that a sworn complaint, a copy of which is attached, has been duly made and filed, requesting a hearing on suspension or revocation of the 2022-2023 “Class B” intoxicating liquor license, a Class “B” fermented malt beverage license, and a Public Entertainment Permit, all issued under license number ALC-22-1, for the premises located at 6922 W. Orchard Street in the City of West Allis, State of Wisconsin, for the license period running July 1, 2022, and expiring on June 30, 2023. This sworn complaint requesting a hearing for suspension or revocation of the above referenced licenses or permits is brought pursuant to the provision of Wis. Stat. § 125.12(2) and West Allis Code §§ 9.51, 9.60(5), and 9.76(5).

NOW THEREFORE, you, EKC Investments LLC by licensing agent Ed Jones, are hereby summoned to appear before the License and Health Committee of the West Allis Common Council on November 15, 2022 at 6:30 p.m., in Room 128 of the West Allis City Hall located at 7525 W. Greenfield Avenue in the City of West Allis, or as soon thereafter as this matter can be heard, to admit or deny the allegations in the complaint. You may be represented by counsel on this date.

In the case of your failure to appear as required by this summons, the allegations in the complaint against you shall be taken as true and, if the License and Health Committee of the West Allis Common Council finds the allegations sufficient, a recommendation that your license(s) be suspended or revoked will be made to the full Common Council. The Common Council may then vote to suspend or revoke your license(s).

You are further notified that if you appear as required by this summons and contest the allegations in the complaint, a hearing will be scheduled at a later date before the License and Health Committee, at which time you may be represented by counsel, cross examine the witnesses who testify adversely against you, and present witnesses in your own behalf. A written transcript of said hearing shall be made and you may obtain a copy of the transcript of this proceeding at your expense.

Dated at West Allis, Wisconsin, this 7th day of November, 2022.

WEST ALLIS COMMON COUNCIL

By: Rebecca N. Grill
Rebecca Grill
City Administrator and City Clerk

**WEST ALLIS COMMON COUNCIL
LICENSE AND HEALTH COMMITTEE
CITY OF WEST ALLIS**

**In the Matter of the
Complaint Against**

COMPLAINT

**EKC Investments LLC
D/B/A Kane's Bar & Grill**

**Premises Location:
6922 W. Orchard St.
West Allis, WI 53214**

Agent: Ed Jones

**STATE OF WISCONSIN)
) ss.
COUNTY OF MILWAUKEE)**

Detective Brandon Hurley of the West Allis Police Department, being duly sworn on oath, deposes and states as a complaint under Wis. Stat. § 125.12(2)(ag) against EKC Investments LLC and doing business as "Kane's Bar & Grill" as follows:

1. That the complainant is a resident of the City of West Allis.
2. That this complaint is based upon information contained within official records maintained by the City of West Allis and the City of West Allis Police Department that the complainant has used in the past and found to be reliable.
3. That EKC Investments LLC, doing business as "Kane's Bar & Grill" has been issued a "Class B" intoxicating liquor license and a Class "B" fermented malt beverage license (together identified on the license as a "Class B Tavern License"), and a Public Entertainment Permit, all issued under license number ALC-22-1, for the premises

located at 6922 W. Orchard Street in the City of West Allis, State of Wisconsin, for the license period running July 1, 2022, and expiring on June 30, 2023.

4. That Ed Jones is the agent appointed pursuant to Wis. Stat. § 125.04(6)(a) for license number ALC-22-1. Kathy Goedde is identified as a vice president of EKC Investments LLC.
5. That EKC Investments LLC first obtained a Class B Tavern and Public Entertainment license for the premises located at 6922 W. Orchard Street on February 9, 2022. This license ran from February until the end of the license period on June 30, 2022. At that time the 2022-2023 license period began under ALC-22-1. Ed Jones was the agent for that license as well.
6. That on July 2, 2022, officers were dispatched to Kane's Bar & Grill at 6922 W. Orchard Street regarding a potential overdose. Officer Roth arrived on scene and made contact with individuals at the bar. Officer Roth observed that a bar employee identified as Kathy G. had overdosed and was on the ground near the bar. The West Allis Fire Department began to render aid. The West Allis Fire Department administered Narcan, a substance used in emergency situations to help reverse the effects of an opioid overdose, which was effective and Kathy G. became responsive. Kathy G. denied taking any illegal substance, despite Officer Schrandt explaining that Narcan only works to counteract opiates.

Officer Roth identified a second employee, Chad H., that appeared to be under the influence of some type of drug. Chad H. originally told officer Roth that Kathy G. had gone outside with an unknown male before the overdose event occurred. Chad H. was confronted about his impairment. He stated that he did not use drugs with his

boss, Kathy G. Chad H. also admitted that he had some “leftover” cocaine on his person. The substance found on his person was described as a white chunky substance, weight of approximately .94 grams. Sergeant Clint Corwin tested that substance using the Nark II (07) Scott Reagent Modified Field Test. The substance tested positive as cocaine base (cocaine).

Two other employees on scene, M.N. and K.P. advised that approximately 15 minutes before the overdose event, they observed Chad H. and Kathy G. go outside for a smoke break. The two remained outside for a period of time and upon returning inside the bar, both were sweating profusely and Kathy G. began to show signs of overdosing.

7. That the above incident occurred exactly ten (10) days after an incident involving the recovery of a firearm and a substantial quantity of drugs, including cocaine, was found in the basement of Limanski’s Pub, another bar that is owned and managed by Kathy Goedde.
8. That police have had other contacts at the property since EKC Investments LLC began to utilize the alcohol license for the premises.
 - A. On March 13, 2022, police conducted a tavern check of the premises and identified that the tavern license was not on display as required by Wis. Stat. 125.04(10)(b).
 - B. Police were also dispatched to the location multiple times between March 26, 2022, through September 24, 2022, for noise complaints and other disturbances from employees or former employees. Those complaints were as follows:

- i. March 26, 2022- Noise complaint identified by a 3rd party. Police were not able to confirm the noise violation and no action was taken by police at that time.
- ii. May 15, 2022- Noise complaint identified by a 3rd party. Police went to the scene and observed the violation. Police asked employees to close the doors.
- iii. May 20, 2022- Noise complaint identified by 3rd party. Police were not able to independently confirm so no action taken by police.
- iv. May 26, 2022- Noise complaint observed although determined not to be loud enough to cause a disturbance at the time officer arrived. Employee stated that someone had the door open briefly but they will continue to keep door closed to avoid issue in future.
- v. September 3, 2022- Noise complaint identified by a 3rd party regarding loud music. Police dispatched but could not independently confirm. No action taken by police at that time.
- vi. September 18, 2022- Current employees contacted police about a former employee, Cassie, banging on the back door and scaring current employees. After the initial call, police were unable to make contact with any individuals involved.
- vii. September 24, 2022- Noise complaint regarding loud music and the doors of the bar being open. Police attempted to contact the bar via telephone but there was no answer. The owner of the bar was contacted and indicated he would handle the matter.

9. That pursuant to Wis. Stat. §125.12(2) any license issued under Wis. Stat. Ch. 125 is subject to suspension or revocation for any of the following:
- A. Violating Wis. Stat. § 125.04(10)(b), per Wis. Stat. § 125.12(2)(ag)1. for failure to display the license;
 - B. Keeping or maintaining a disorderly or riotous, indecent or improper house in violation of Wis. Stat. § 125.12(2)(ag)2.; and
 - C. Knowingly allowing another person or employee on the premises who possesses with the intent to distribute or deliver a controlled substance or controlled substance analog in violation of Wis. Stat. § 125.12(2)(ag)6.
10. That pursuant to West Allis Municipal Code §§ 9.51b. and 9.51d. the Public Entertainment Permit is subject to suspension or revocation when the operator has failed to maintain order on the premises and has caused a public nuisance at the property, demonstrated by the noise complaints and more pressingly by employees using and sharing controlled substances at the premises.

WHEREFORE, Detective Brandon Hurley requests that the licensees named herein, EKC Investments LLC, be summoned to appear before the License and Health Committee of the West Allis Common Council to answer this complaint and, if the material allegations of the complaint are denied, that a hearing be held to determine whether the licenses and permits issued to EKC Investments LLC, should be revoked or suspended.

[This space left blank. Signature page to follow]

Dated this 1st day of November, 2022.

By: Det. B. Hurley, #66

Print Name: Det. B. Hurley, #66
City of West Allis Police Department

Subscribed and sworn to before me
this 1 day of November, 2022.

Nicholas S. Cerwin
(Nicholas S. Cerwin)

Notary Public, State of Wisconsin
My Commission expires: Permanent

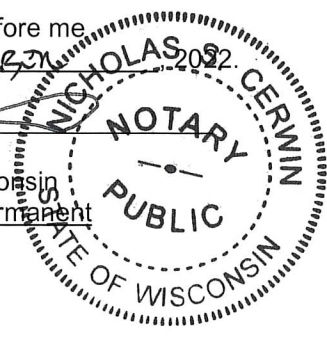



City of West Allis

Meeting Minutes

License and Health Committee

Aldersperson Vincent Vitale, Chair

Aldersperson Suzzette Grisham, Vice-Chair

Alderspersons: Rosalie L. Reinke, Daniel J. Roadt, and Tracy Stefanski

Tuesday, October 18, 2022

6:00 PM

City Hall, Room 128
7525 W. Greenfield Ave.

REGULAR MEETING

A. CALL TO ORDER

Ald. Vitale called the meeting to order at 6:00 p.m.

B. ROLL CALL

Present 5 - Vitale, Grisham, Reinke, Roadt, and Stefanski

C. NEW AND PREVIOUS MATTERS - DISCUSSION PURPOSES ONLY

1. [2022-0956](#) 2022-2024 New Operator's License (Bartender/Class D Operator) application for Jessica Nankin. (BART 356)
Held due to non-appearance at October 4, 2022 License & Health meeting.
Discussion only.
2. [2022-1028](#) 2022-2024 New Operator's License (Bartender/Class D Operator) application for Carvelle Coleman, III. (BART 377)
Discussion only.
3. [2022-1029](#) 2022-2024 New Operator's License (Bartender/Class D Operator) application for Dawn Bonek. (BART 383)
Discussion only.
4. [2022-1030](#) NEW - BART 382 - Abimael Torres Garcia.
Held due to non-appearance at October 18, 2022 License & Health meeting.
Discussion only.
5. [2022-1019](#) New Class B Tavern License application for HayKar Z LLC, d/b/a Brass Boar's Den, 7127 W. National Avenue. Agent: Frank Zoboroski. (ALC 22 205)
Discussion only.
6. [2022-1020](#) New Class A Beer License application for Badger State Petroleum Inc., d/b/a Oklahoma BP, 10731 W. Oklahoma Avenue. Agent: Jasmeet Kang. (ALC 22 208)
Discussion only.

- 7. [2022-1021](#) New Class B Tavern License application for The Fan Zone Inc., d/b/a Fan Zone Sports Bar, 6741 W. Lincoln Avenue. Agent: Asia Beckum. (ALC 22 206)

Discussion only.

D. ADJOURNMENT

Ald. Grisham moved to adjourn at 6:16 p.m., Ald, Stefanski seconded, motion carried.



All meetings of the {bdName} are public meetings. In order for the general public to make comments at the committee meetings, the individual(s) must be scheduled (as an appearance) with the chair of the committee or the appropriate staff contact; otherwise, the meeting of the committee is a working session for the committee itself, and discussion by those in attendance is limited to committee members, the mayor, other alderpersons, staff and others that may be a party to the matter being discussed.

NON-DISCRIMINATION STATEMENT

The City of West Allis does not discriminate against individuals on the basis of race, color, religion, age, marital or veterans' status, sex, national origin, disability or any other legally protected status in the admission or access to, or treatment or employment in, its services, programs or activities.

AMERICANS WITH DISABILITIES ACT NOTICE

Upon reasonable notice the City will furnish appropriate auxiliary aids and services when necessary to afford individuals with disabilities an equal opportunity to participate in and to enjoy the benefits of a service, program or activity provided by the City.

LIMITED ENGLISH PROFICIENCY STATEMENT

It is the policy of the City of West Allis to provide language access services to populations of persons with Limited English Proficiency (LEP) who are eligible to be served or likely to be directly affected by our programs. Such services will be focused on providing meaningful access to our programs, services and/or benefits.